



CHIKO 

Solar Mounting Solutions

Mount Bracket



About us

CHIKO's origins date to 2008, as a high technology company that specializes in providing the solar mounting solutions in addition to design, manufacturing and selling, for utilities, commercial, industrial and residential projects. Headquartered in Shanghai, China. CHIKO has set up the office and warehouse across several countries including Australia, the United States, Mexico, Nederland, South Africa, United Arab Emirates, India, Thailand, Vietnam, Philippines, and Korea.

CHIKO, create the values for customers!

With over 12GW installations completed in more than two dozen countries, CHIKO solar mounting products performs excellent that greatly improved the stability of the solar power plant, successfully has been one of the largest solar racking providers in the world.

History

12GW Milestone 2020.



2019.
Solar Tracking Launched



2018.
Built Branch in Korea



2016.~2017.
Preparations Are Ready For
Penetrating Into U.S. Markets



2015.
4GW Milestone

2012.~2015
Set Up Office In Australia,
Nederland, Thailand etc.



2011. Acquired Certifications For
Mounting Products

2010.
Foundation CHIKO Solar
Specializes In Solar
Mounting Structure



2007.
Founded As Solar Power Venture



Cetification

Chiko R&D team, of more than 10 peoples, 4 designers and 7 civil engineers leading by the doctor who registered as the 1st class structural engineer in China, is the members of various international organizations to set the standards for our products. Currently, Chiko products owns several ceertifications by the third parties like, UL, SGS,Gamcorp, Intertek, and SPAD etc.We Continuously accelerate the developing of new products and technolgies, from its strength in fixed solar mounting to solar tracking system and energy storages.



Patents



Production

CHIKO strives towards high operational efficiency. We operate two manufacturing facilities in Shanghai and Suqian, Totally covering 30,000 square meters and 8 production lines which allows Chiko maintain 1.8GW of annual capacity for aluminum and steel products. With the new building set up by the early of 2020, we are aims to accelerate the automation of the equipments, to achieve it 80% in the next 3 years for automate processing, automate machining, automate cleaning, and automate packing. From production to management, maintain its leading position in the solar industry.



Culture

Mission:

- Adhere to innovation
- To meet customers' requirements
- To win global market
- To keep excellent and professional
- To build first-class green energy CHIKO brand

Value:

- Communication
- Win-win Benefits
- Cooperation,
- Service
- Competition

Spirit:

- Professional focus
- Full participation;
- Great unity,
- Open and profound mind

Vision:

- Sincere credibility and top-level of service
- Scientific standard and high-quality of products

The First Sun



Index

» TILE ROOF MOUNT BRACKET	1-8
Pantile Mount Side Fixing	
Pantile Mount Bottom Fixing	
Flat Tile Mount	
Crown Mount	
Asphalt Shingle Mount	
Standoff Mount	
Stainless Steel Hook	
» METAL ROOF MOUNT BRACKET	9-16
L Feet Mount	
Hanger Bolt Mount	
Trapezoidal Clamp Mount	
Rail-Free Mount	
Lysaght Klip-lok Mount	
E-LOCK Mount	
Tilt Mount	
Standing Seam Clamps	
» FLAT ROOF MOUNT BRACKET	17-24
Ballast I-2 Mount	
Ballast I-3 Mount	
Ballast III Mount	
Ballast VI Mount	
Adjustable Aluminum Triangular Mount	
Fixed Aluminum Triangular Mount	
Classic Rail #7	
Infit Rail	
» GROUND MOUNT	25-31
Aluminum T2VC Mount	
Steel U2V Mount	
Steel Pipe Mount	
Pile-Driven Mount	
Single Pole Carport	
Four Poles Carport	
Adjustable Steel Ground Mount	
» ROOFTOP EARTHING	32
» GROUND SCREW & ANCHOR	33-34
» CABLE ACCESSORY	35-37
Cable Clip	
Stainless steel cable tie	
PV Connectou	
PV Cable	
» PROJECTS REFERENCE	38-40

Pantile Mount Side Fixing

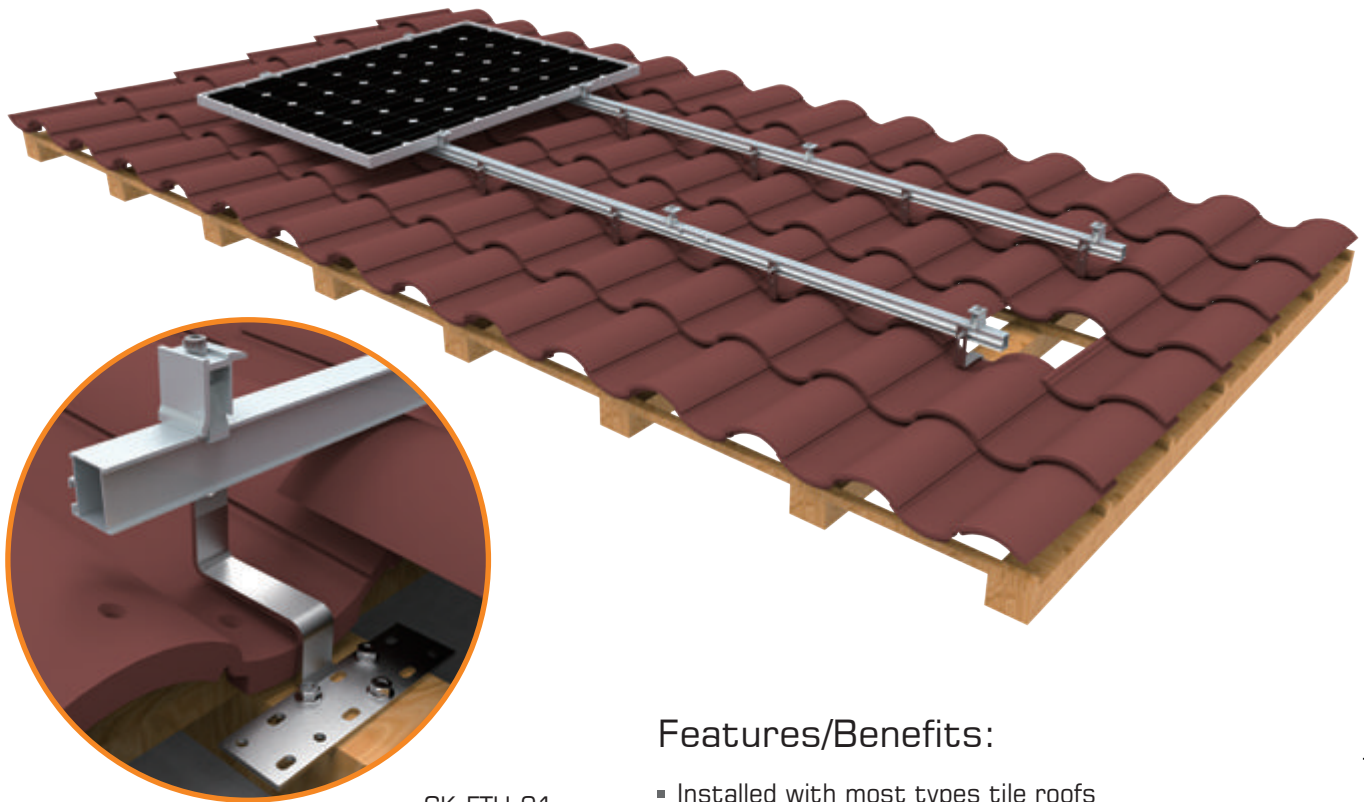

Features/Benefits:

CK-FTH-01

- Installed with most types tile roofs
- Portrait & Landscape orientation
- Pre-assembled
- Made of SUS 304
- Height adjustable
- Easy installation



Portrait Orientation

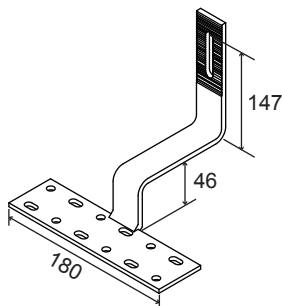

CK-FTH-01

Landscape Orientation

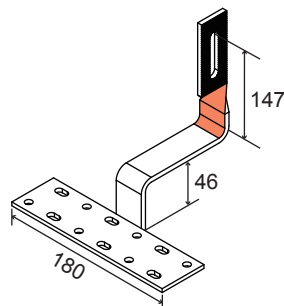

CK-FTH-01B

Height Adjustable

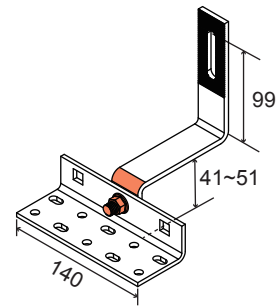

CK-FTH-09

Pantile Mount Bottom Fixing

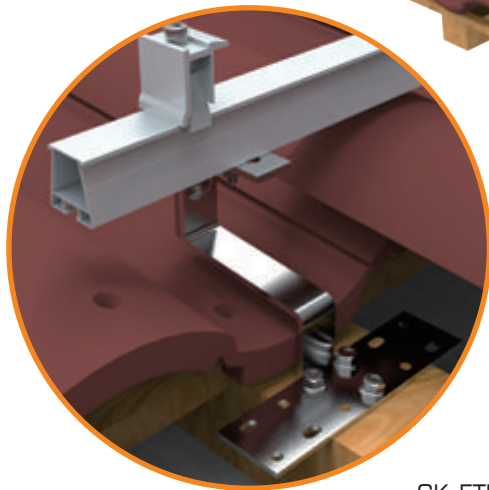
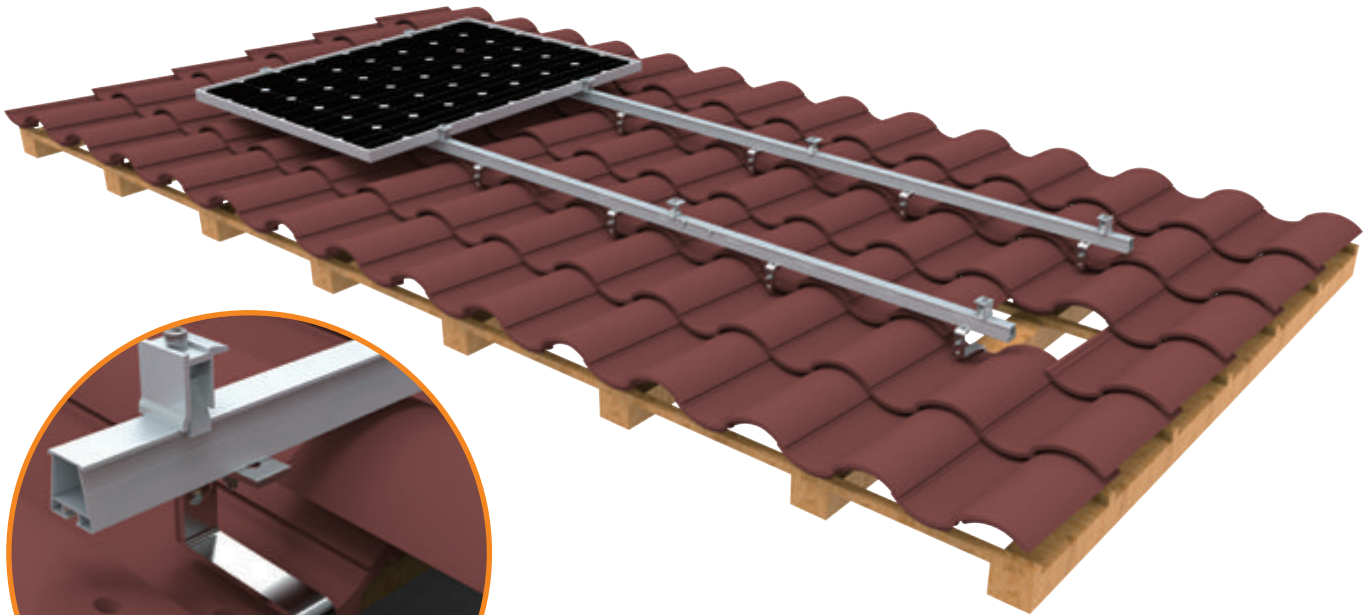

CK-FTH-073



Features/Benefits:

- Installed with most types tile roofs
- Portrait & Landscape orientation
- Pre-assembled
- Made of SUS 304
- Height adjustable
- Easy installation
- Firmly bottom fixing

Height adjustable over tile

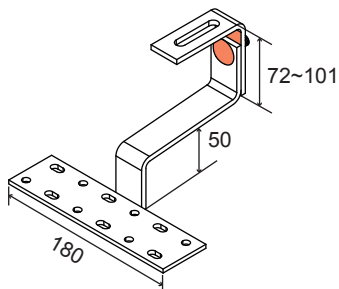

CK-FTH-073

Height adjustable at batten

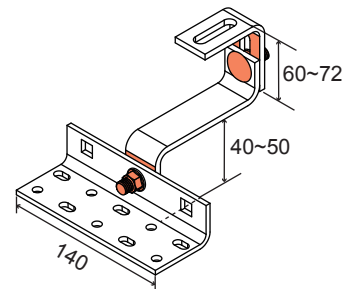

CK-FTH-09V

Flat Tile Mount

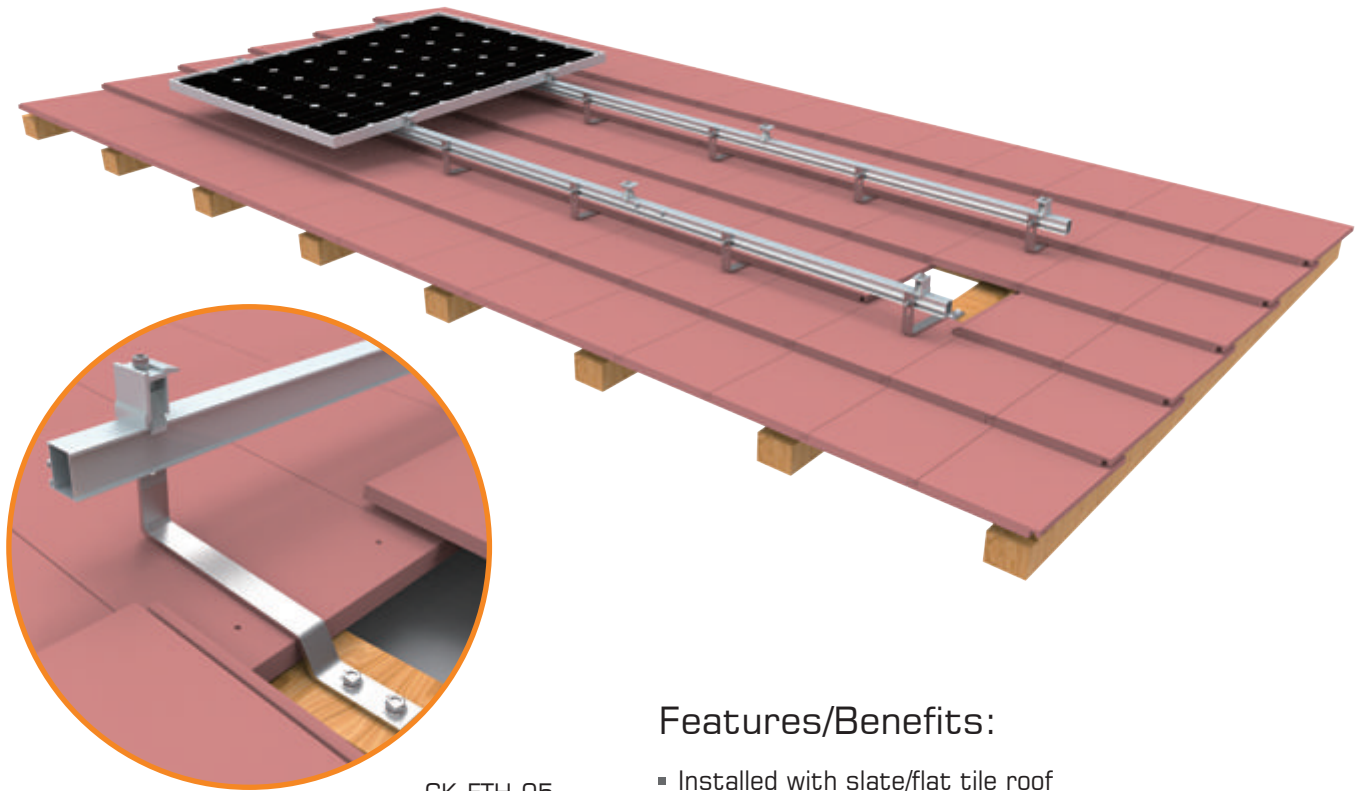

CK-FTH-05

Features/Benefits:

- Installed with slate/flat tile roof
- Portrait & Landscape orientation
- Pre-assembled
- Made of SUS 304
- Height adjustable
- Easy installation



Portrait orientation

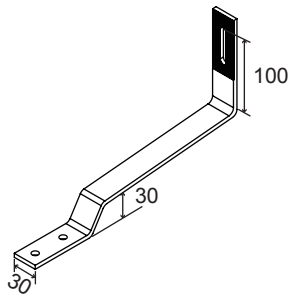

CK-FTH-05

Landscape orientation

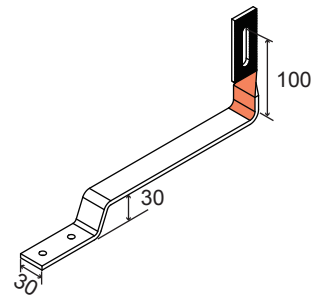

CK-FTH-05B

Crown Mount

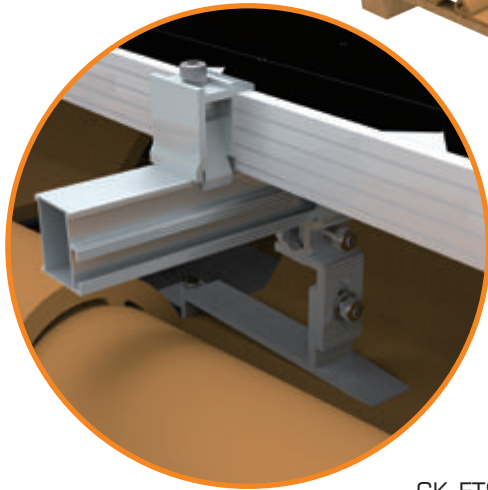
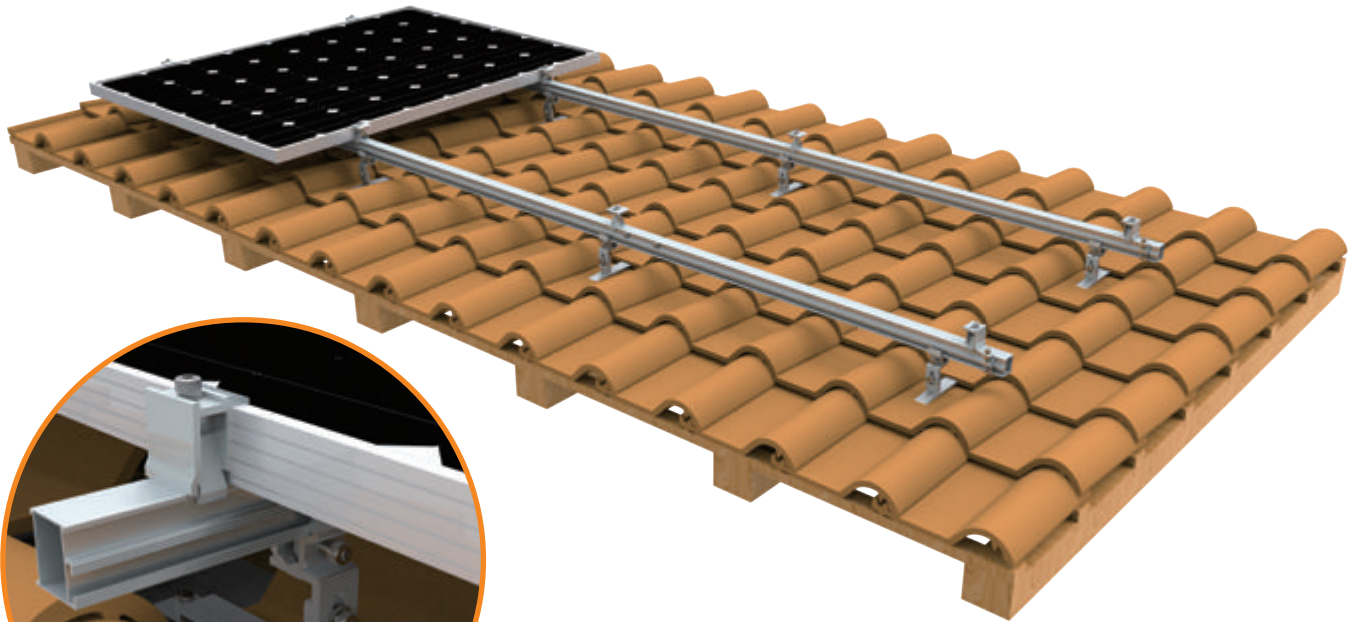

CK-FTS-385

Features/Benefits:

- Bottom carrying of rail achieved easily by side fastening
- Module orientation switched easily by rotatable adapter
- Made of AL 6005-T5
- High-class surface anodizing
- Pre-assembled
- Height adjustable



Tulip Mount

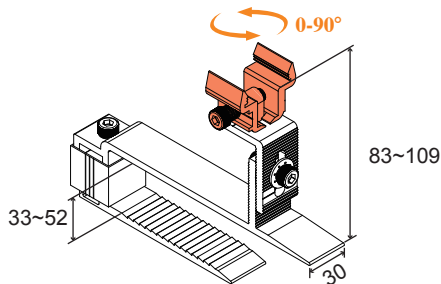

CK-FTS-385

Arc Mount

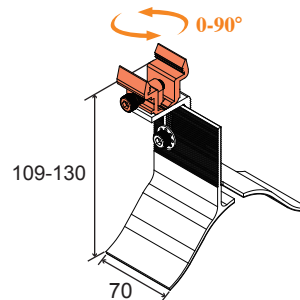

CK-FTS-360

Asphalt Shingle Mount

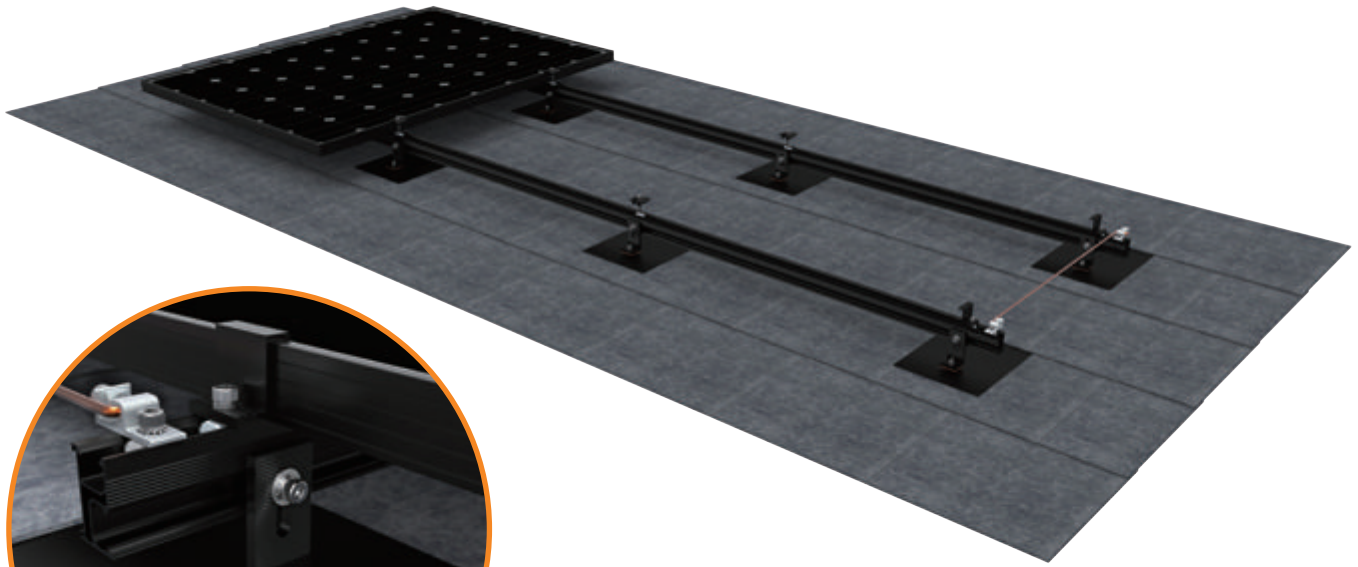

CK-FTS-162T2-5



Features/Benefits:

- Installed with Asphalt Shingle Roof
- Portrait and Landscape orientation
- Made of AL 6005-T5
- High-class surface anodizing
- Pre-assembled
- Waterproof silicon rubber and flashing integrated
- Easy installation

Specifications

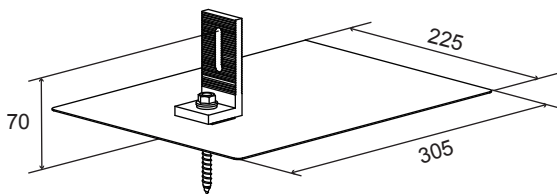

Waterproofing

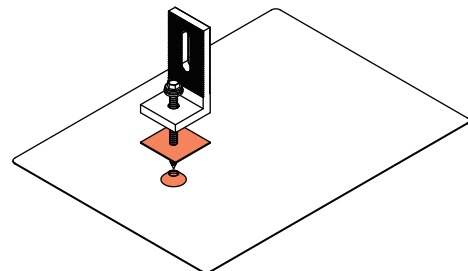

Standoff Mount

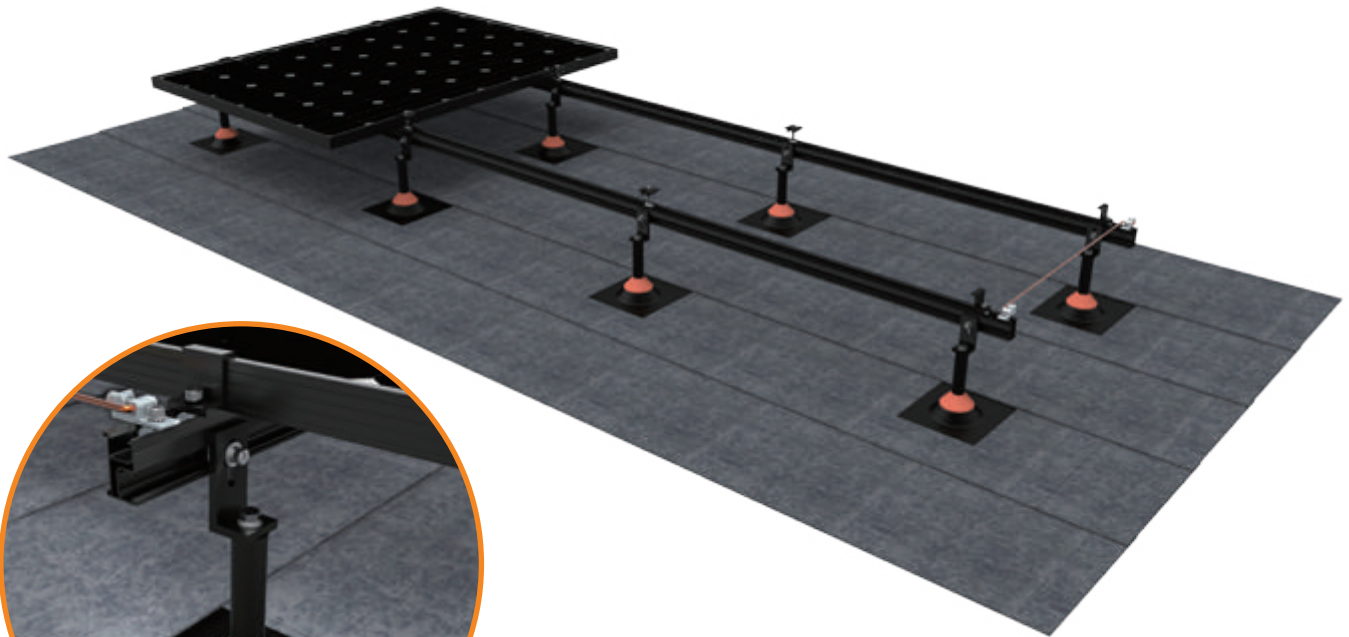

CK-FTS-162T2-3

Features/Benefits:

- Installed with any type flat roof
- Portrait and Landscape orientation
- Made of AL 6005-T5
- High-class surface anodizing
- Pre-assembled
- Waterproof silicon rubber and flashing integrated
- Different Height available
- Easy installation



Height Options

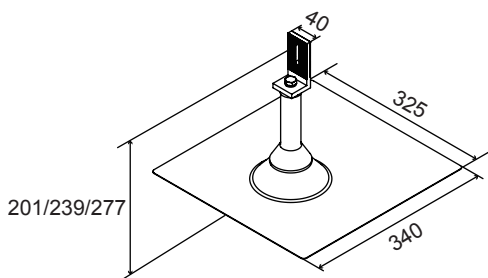



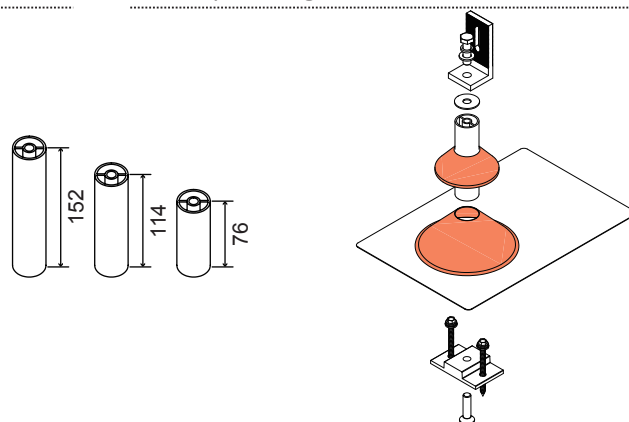





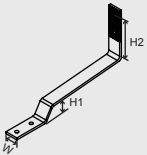
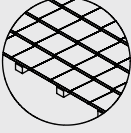

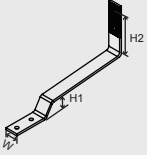
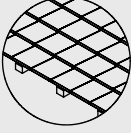
Waterproofing

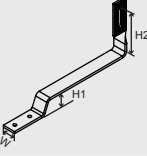
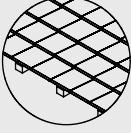

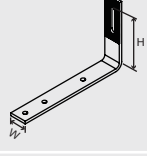
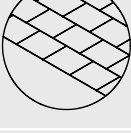
Stainless Steel Hook

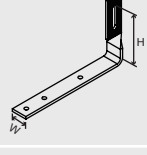
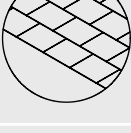
Type No.	Image	Technical	Dimensions	Tile Roof Type
CK-FTH-01			H1=46 H2=147 W=180	
CK-FTH-78			H1=66~98 H2=101 W=180	
CK-FTH-09			H1=41~51 H2=99 W=140	
CK-FTH-79			H1=41~51 H2=99 W=140	
CK-FTH-01B			H1=46 H2=147 W=180	
CK-FTH-09B			H1=41~51 H2=99 W=140	
CK-FTH-73			H1=50 H2=72~101 W=180	
CK-FTH-09V			H1=40~50 H2=60~72 W=140	

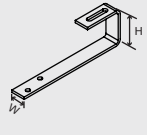
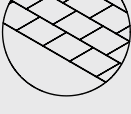
Type No.	Image	Technical	Dimensions	Tile Roof Type
CK-FTH-05			H1=30 H2=100 W=30	
CK-FTH-81			H1=30 H2=100 W=30	
CK-FTH-05B			H1=30 H2=100 W=30	
CK-FTH-07			H=101 W=30	
CK-FTH-07B			H=101 W=30	
CK-FTH-61			H=75 W=30	

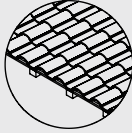
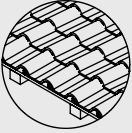
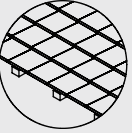
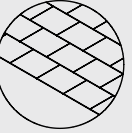
Pantile	Roman tile	Flat tile	Asphalt Shingle
			

L Feet Mount

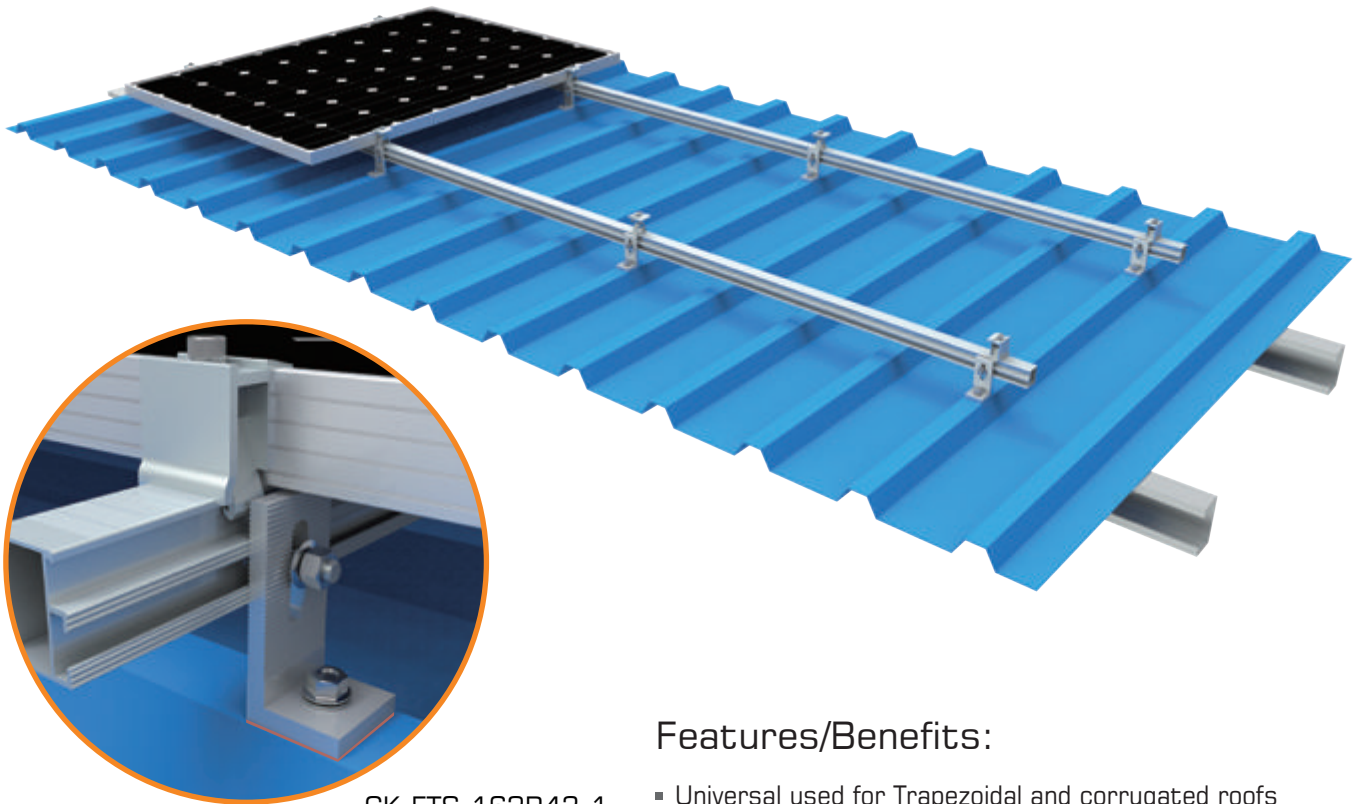

CK-FTS-162R43-1

Features/Benefits:

- Universal used for Trapezoidal and corrugated roofs
- Portrait or Landscape orientation
- Pre-assembled
- Made of high class material AL6005-T5
- Pre-Applied EPDM pad



Length Options

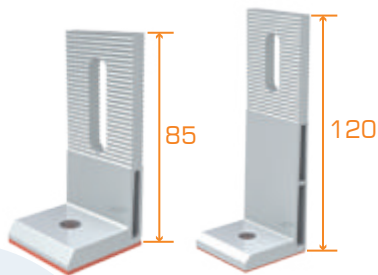

Apply with Hanger Bolt



Work with roof clamps

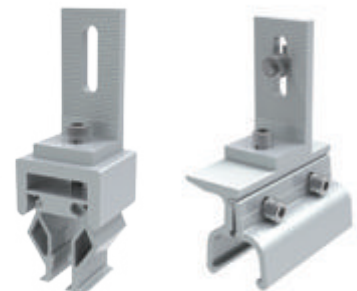

Hanger Bolt Mount

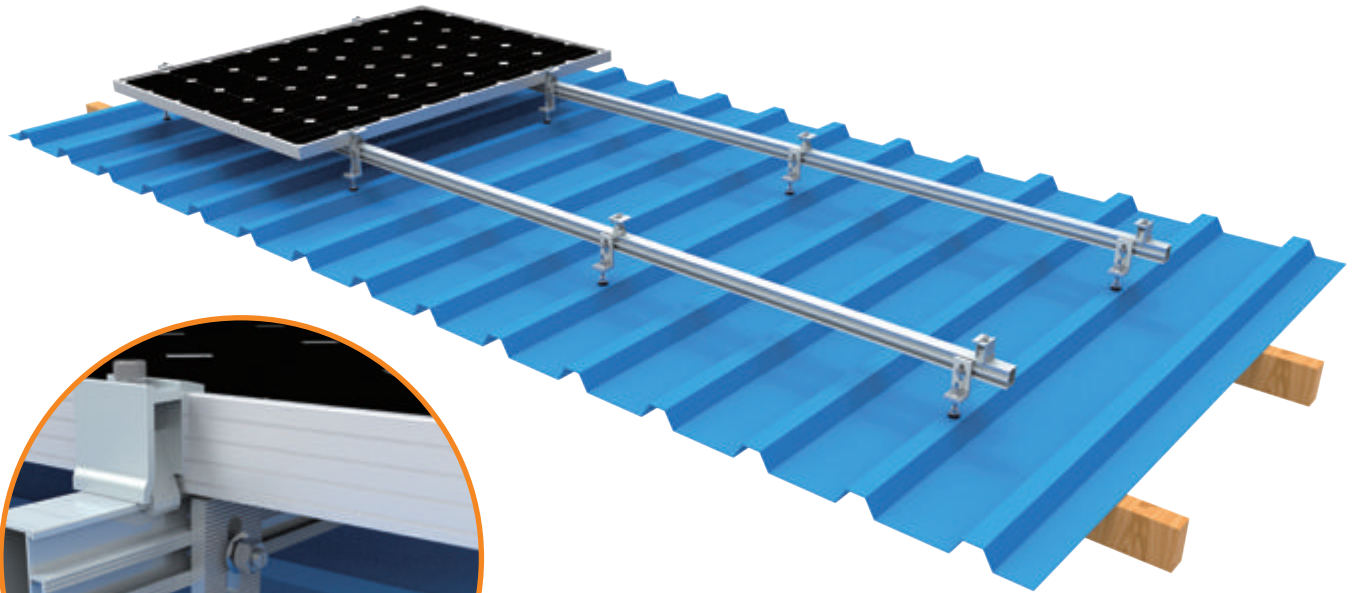

CK-FTS-162R43-7

Features/Benefits:

- Universal used for fibre-cement, trapezoidal and corrugated roofs
- Portrait or Landscape orientation
- Pre-assembled
- Made of high class material AL6005-T5
- Height adjustable and help to increase power generation



For Wooden Rafter



CK-HS-003-B1200/250/300

For Steel Purlin



CK-HS-001-C120/160/200

Combined with Alu Plate



Trapezoidal Clamp Mount

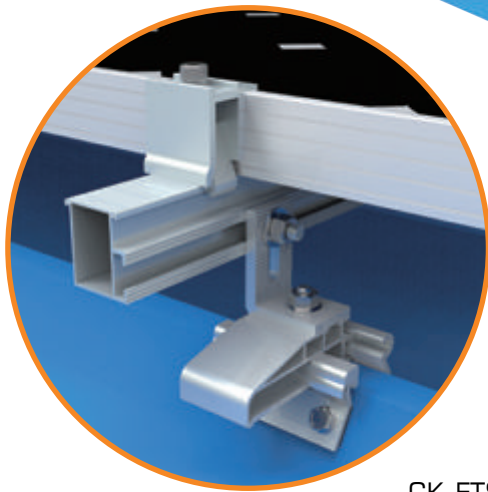
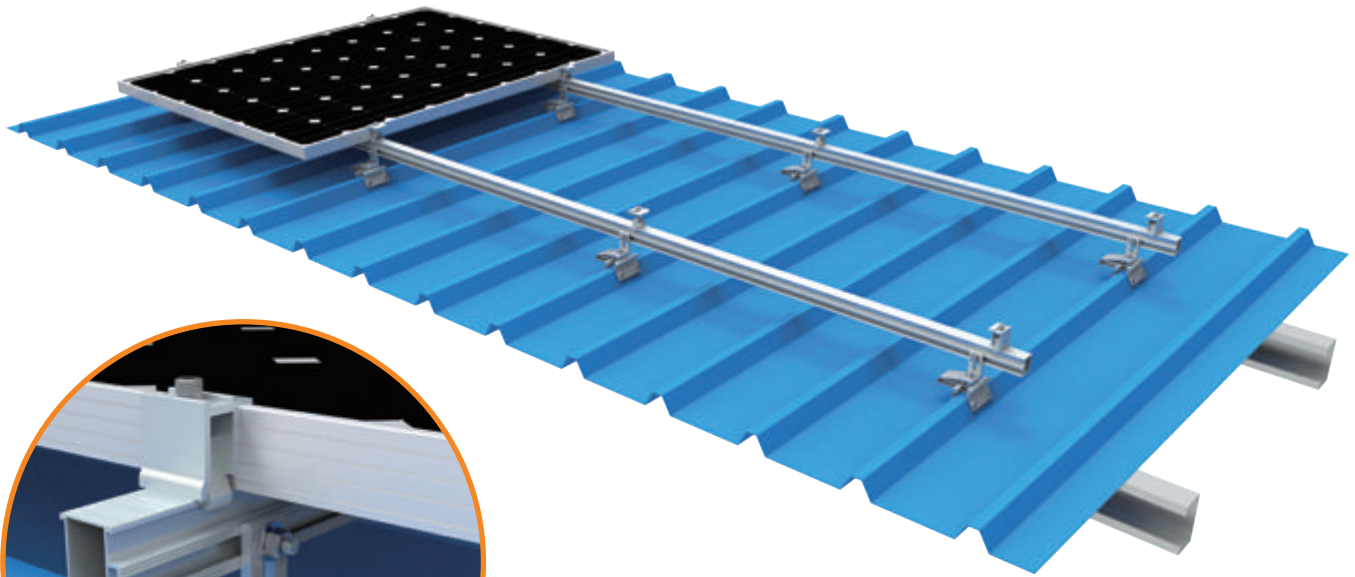

CK-FTS-384

Features/Benefits:

- Application on the trapezoidal roof profile
- Portrait or Landscape orientation
- Made of high class material AL6005-T5
- Every size of module array possible
- Components configured completely, no need extra parts purchasing
- Share the roof loading



Top Drilling

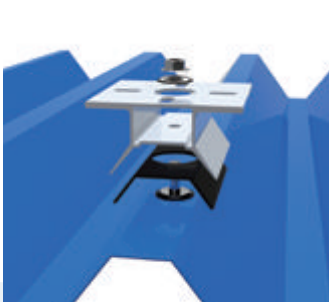

CK-FTS-320



CK-FTS-352

Side Drilling



CK-FTS-381



CK-FTS-395

Rail-Free Mount

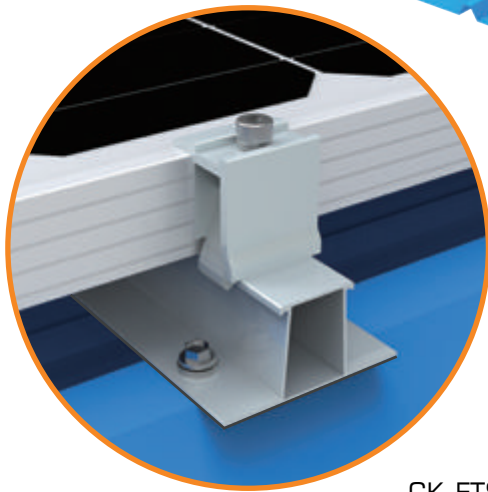
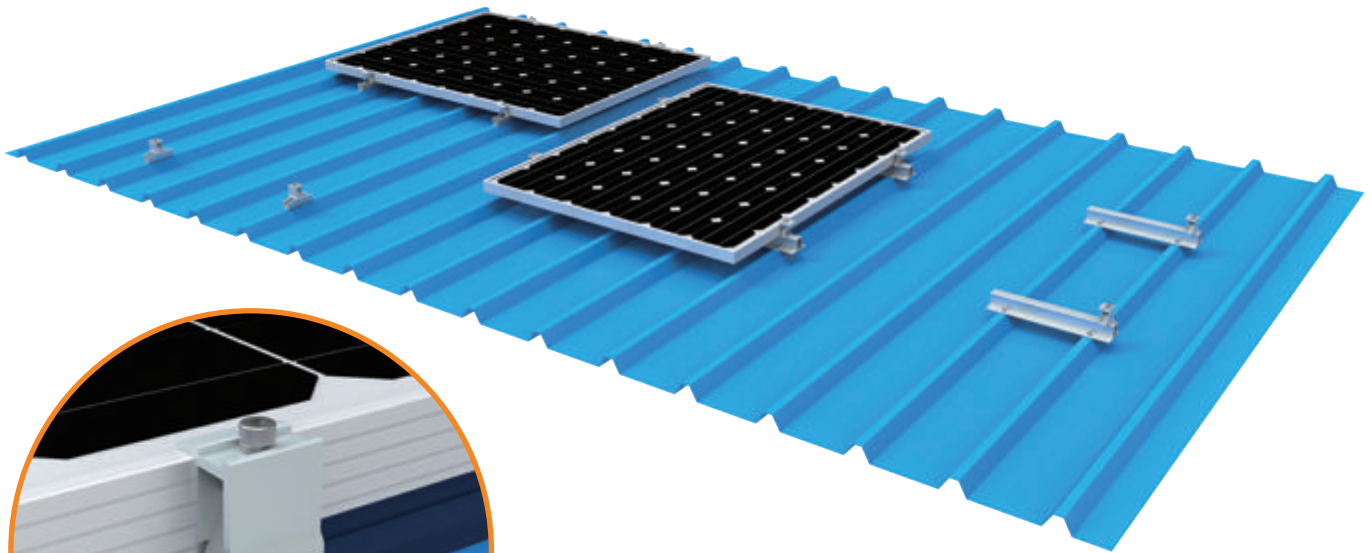

CK-FTS-017

Features/Benefits:

- Application on the trapezoidal and Sandwich roof profile
- Portrait orientation
- Made of high class material AL6005-T5
- Lower Costing & Fast fixing
- Fix on ribs only ,no need drill purlin
- Pre-assembled with EPDM pad



Different height for option

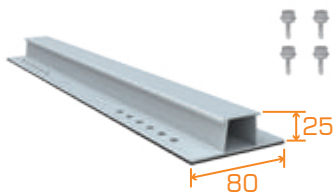

CK-FTS-016

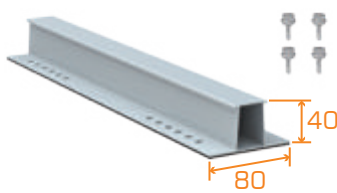

CK-FTS-017

Portrait&Landscape Orientation

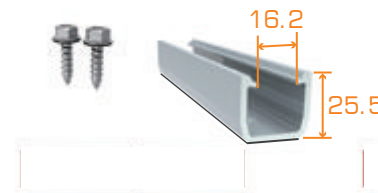

CK-FTS-022

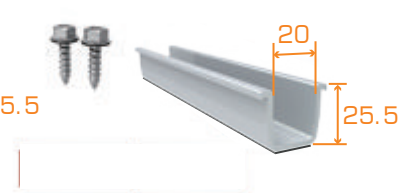

CK-FTS-012

Lysaght Klip-lok Mount

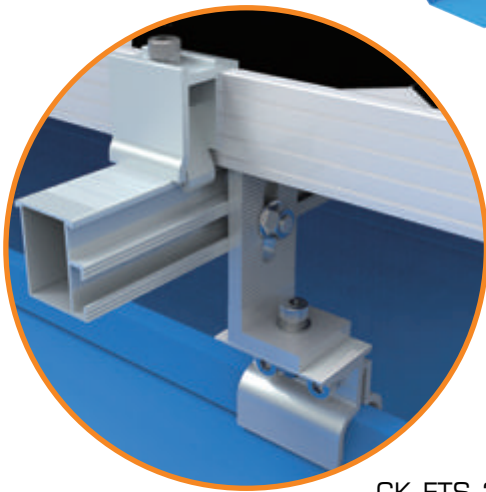
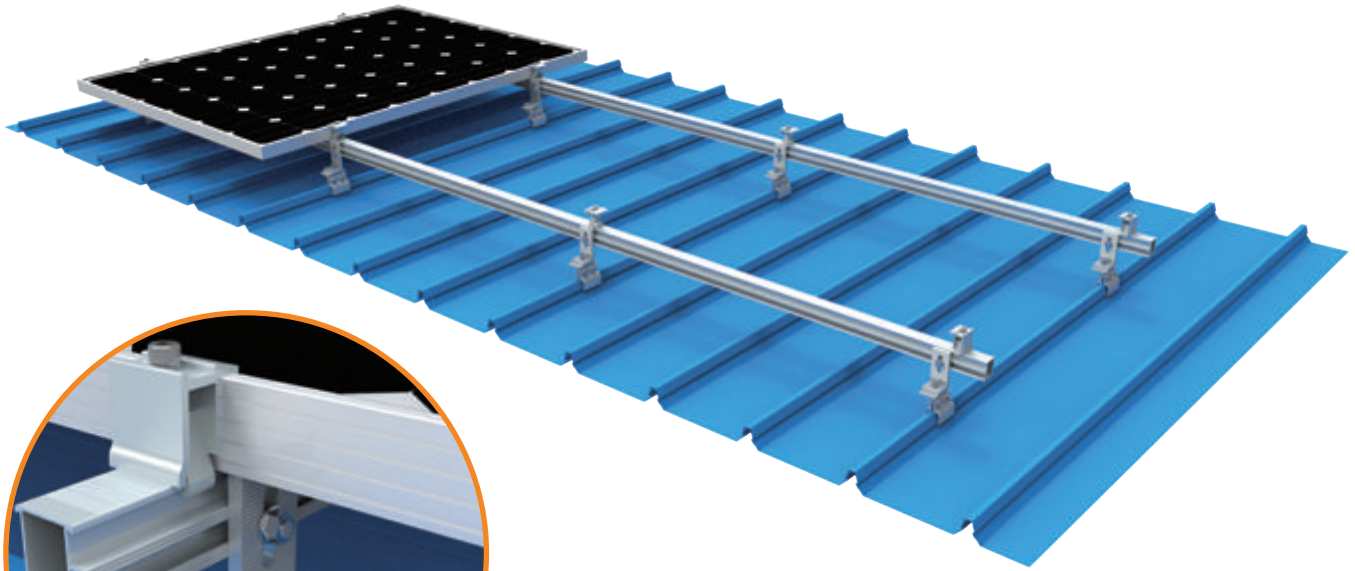

CK-FTS-370/371

Features/Benefits:

- Application on the Lysaght Klip-lok 406 & 700
- Portrait or Landscape orientation
- Made of high class material AL6005-T5
- Every size of module array possible
- Share the roof loading
- Non-penetration installation



Klip-lok Series



CK-FTS-370



CK-FTS-351



CK-FTS-336

E-LOCK Mount

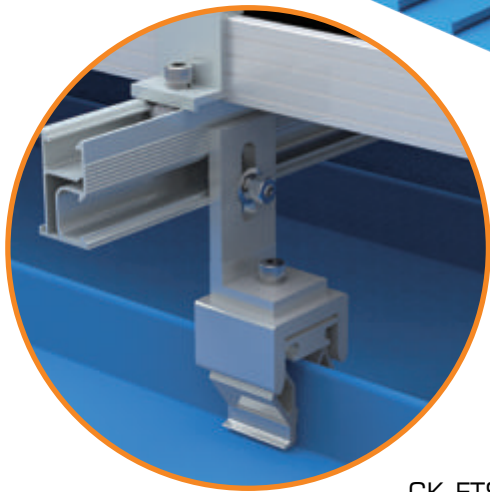
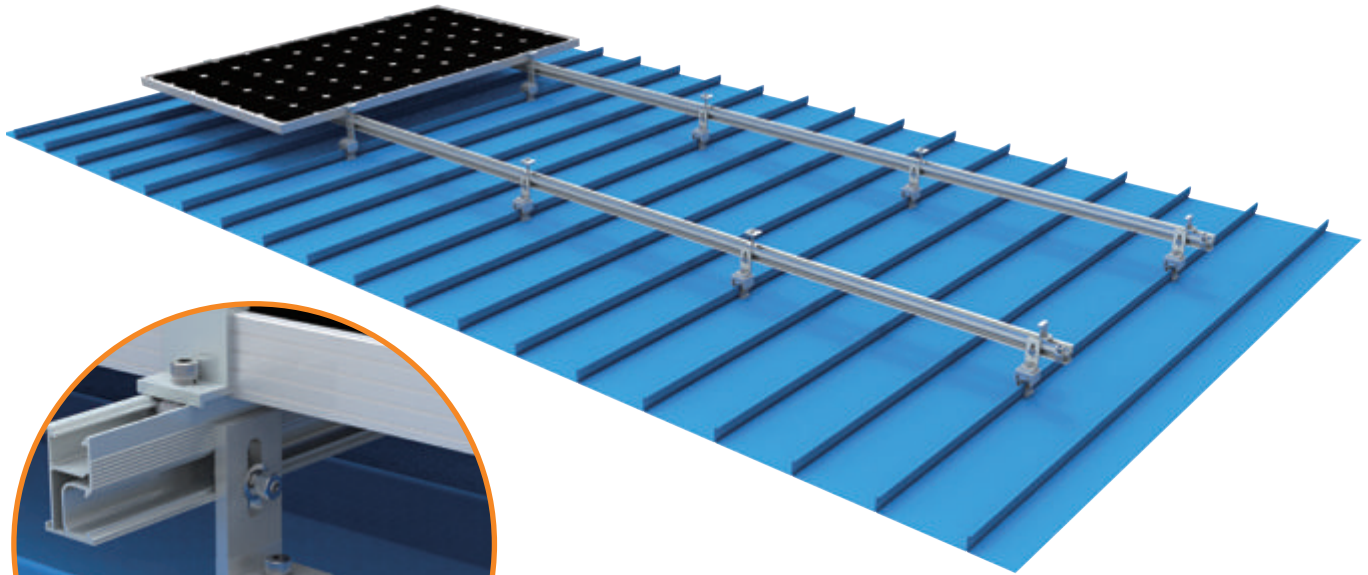

CK-FTS-388



Features/Benefits:

- ·Used on different seam roofs
- ·Portrait and Landscape orientation
- ·Made of high class material AL6005-T5
- ·One bolts fixing ,saving installation time and process
- ·Unique design with non-penetrating solutions

Customized Shapes For Roofing Profiles



CK-FTS-389



CK-FTS-376



CK-FTS-388

Tilt Mount

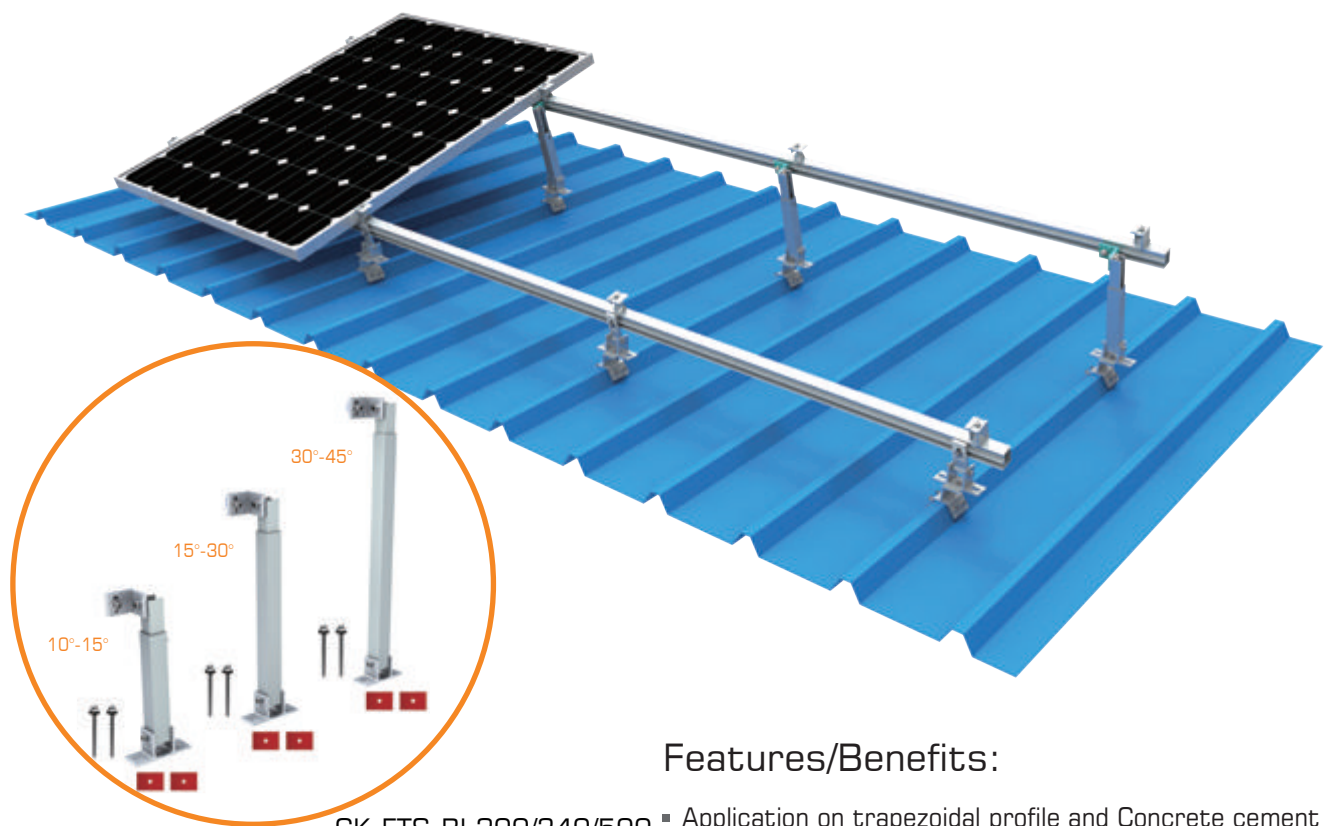

Features/Benefits:

- Application on trapezoidal profile and Concrete cement roofs
- Portrait or Landscape orientation
- Made of high class material AL6005-T5
- Different tilt options
- Optimizing the tilt to increase power generations

CK-FTS-BL200/340/500



L footing

Combined with roof clamp

Free direction possible

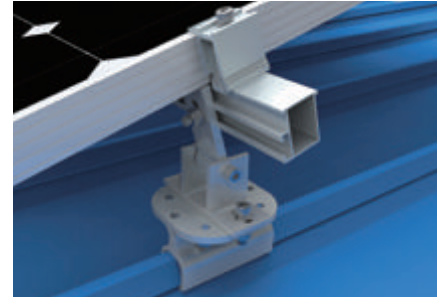

Standing Seam Clamps

Type No.	Image	Profile reference	Material
CK-FTS-371			AL 6005-T5
CK-FTS-370			AL 6005-T5
CK-FTS-351			AL 6005-T5
CK-FTS-336			AL 6005-T5
CK-FTS-365			AL 6005-T5
CK-FTS-331			AL 6005-T5
CK-FTS-349			AL 6005-T5
CK-FTS-355			AL 6005-T5

Ballast I-2 Mount

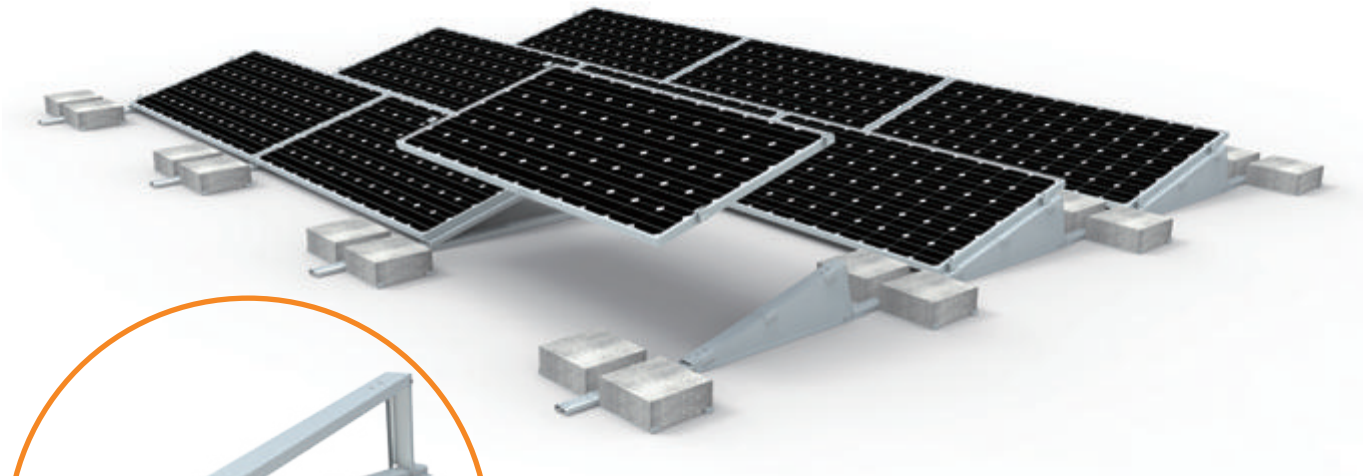

CK-BT21

Features/Benefits:

- Most universal for commercial flat roofs
- 1 panel Landscape orientation & East to West
- 10°, 15°, 20°, 25°, 30° tilted angle available
- Various modules configurations are possible
- Made of AL 6005-T5
- Highly class anodizing on surface treatment
- Pre-assembly and foldable
- Non-penetration to roof and light weight roof loading



East to West Configurations:

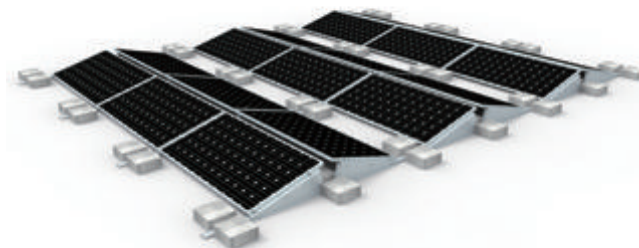
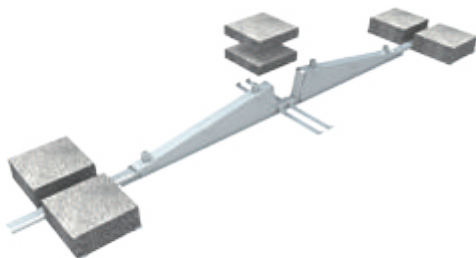

Ballast I-3 Mount

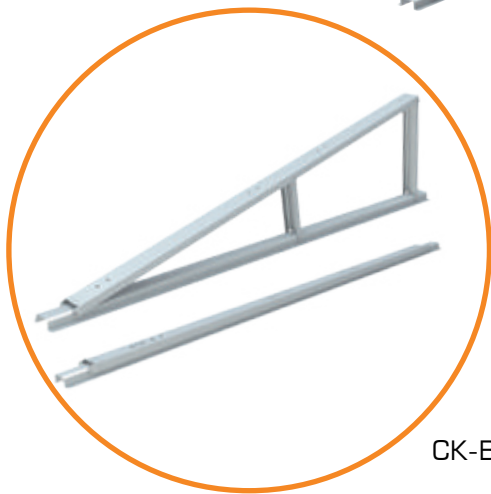
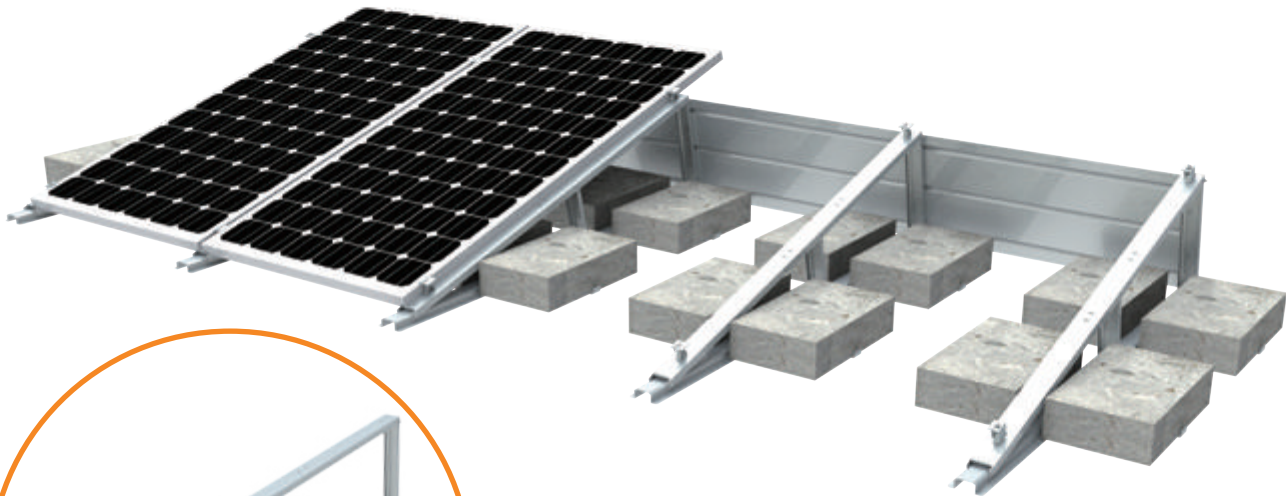

CK-BT31

Features/Benefits:

- Most universal for commercial flat roofs
- 1 panel Portrait & 2 panels Landscape orientation
- 10°, 15°, 20°, 25°, 30° tilted angle available
- Various modules configurations are possible
- Made of AL 6005-T5
- Highly class anodizing on surface treatment
- Pre-assembly and foldable
- Non-penetration to roof and light weight roof loading



Customized Configurations

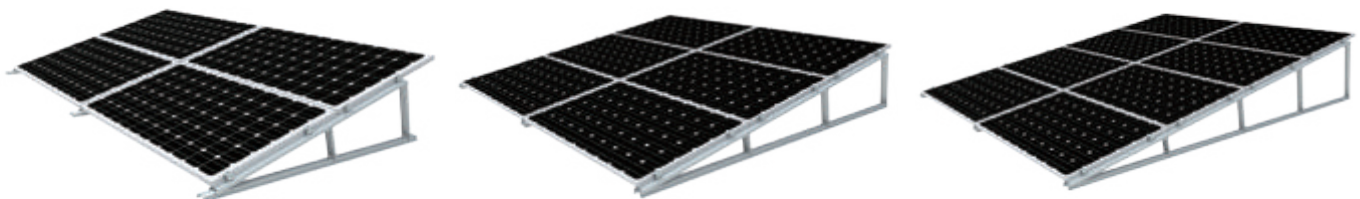

Ballast III Mount

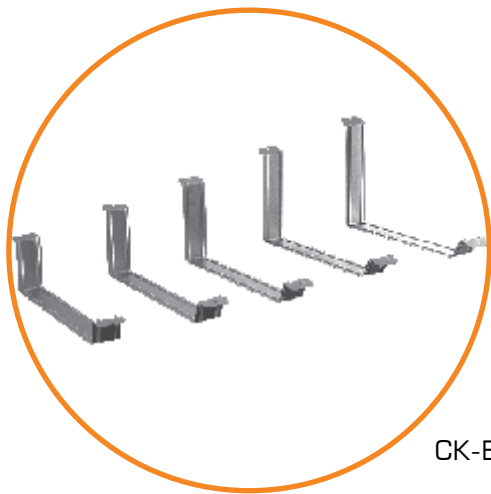

CK-BL-3

Features/Benefits:

- Most cost-effective for commercial flat roofs
- 1 panel Landscape orientation
- 10°, 15°, 20°, 25°, 30° tilted angle available
- Various modules configurations are possible
- Made of Aluminum
- 1 step installation
- Non-penetration to roof and light weight roof loading



Simple Installations



Ballast VI Mount

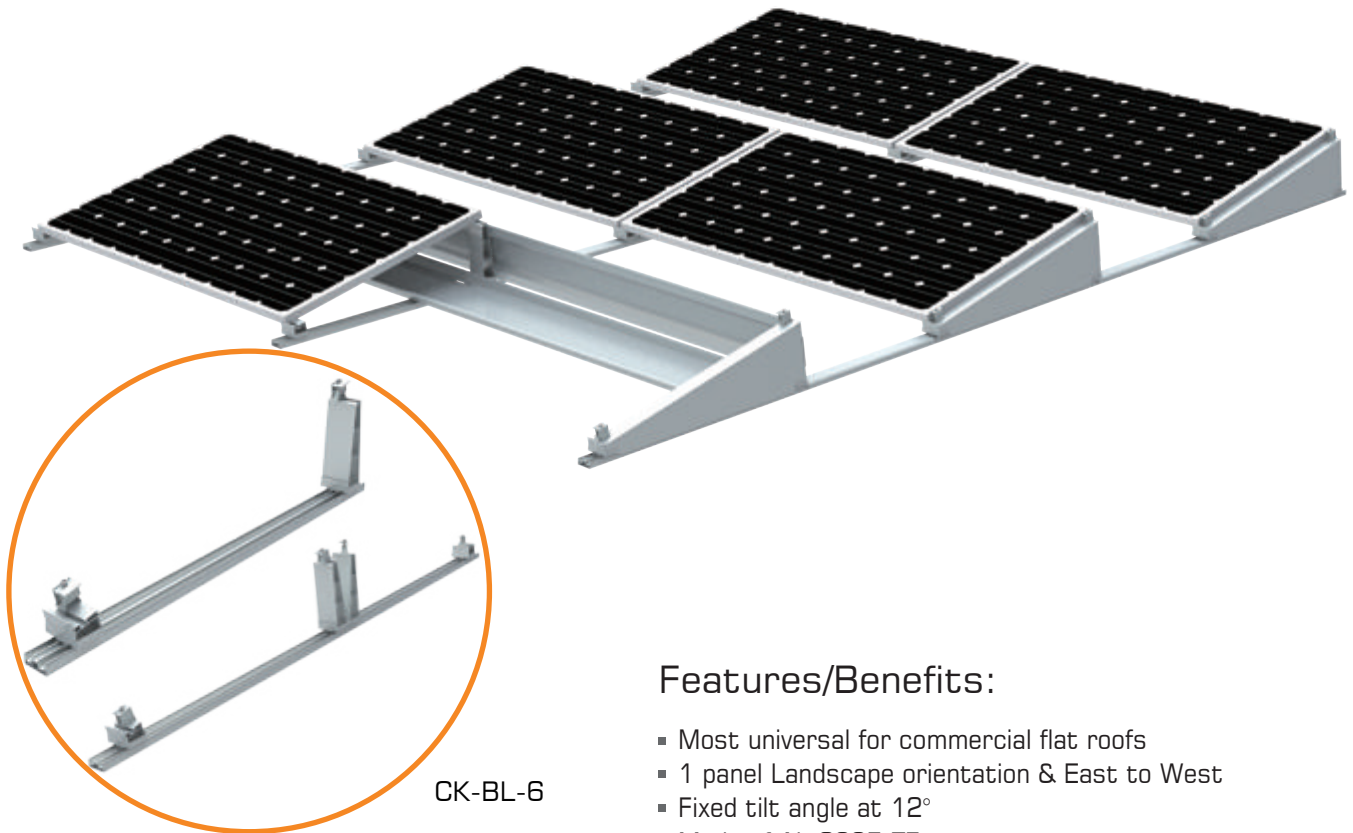

Features/Benefits:

- Most universal for commercial flat roofs
- 1 panel Landscape orientation & East to West
- Fixed tilt angle at 12°
- Made of AL 6005-T5
- Highly class anodizing on surface treatment
- Only 1 tools installation needed for all fixing
- Pre-assembly
- Non-penetration to roof and light weight roof loading



Ballast Placement Options

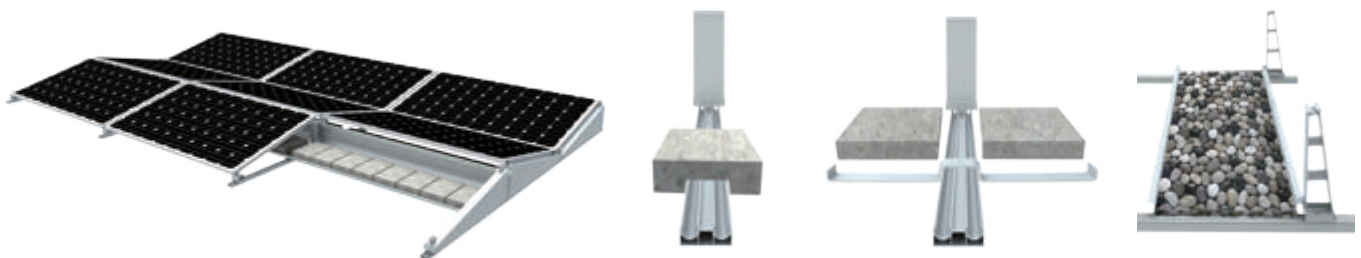

Adjustable Aluminum Triangular Mount

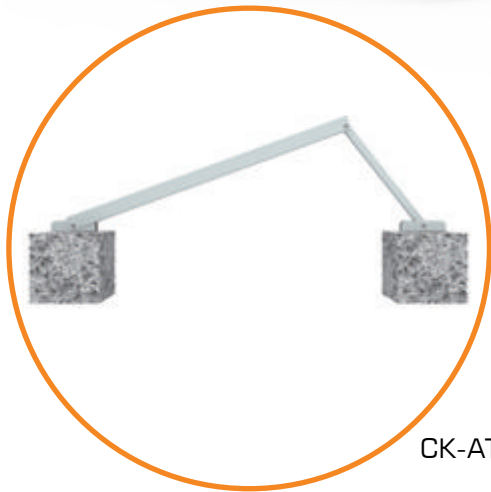
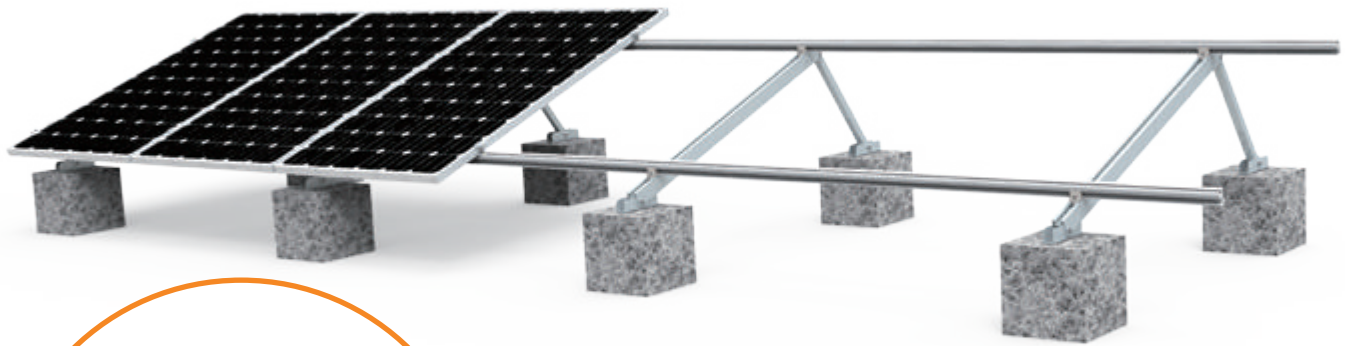

CK-ATT-BL

Features/Benefits:

- Most cost-effective for commercial flat roofs
- 1 panel Portrait orientation
- 10°-30° tilted angle adjustable
- Made of AL 6005-T5
- Highly class anodizing on surface treatment
- Pre-assembly and foldable
- Non-penetration to roof and light weight roof loading



Angel Adjustable by moving the concrete distance

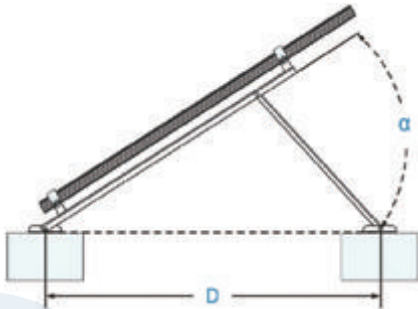

Degree	Concrete Distance(D/mm)
15°	1216
20°	1547
25°	1716
30°	1832

Fixed Aluminum Triangular Mount

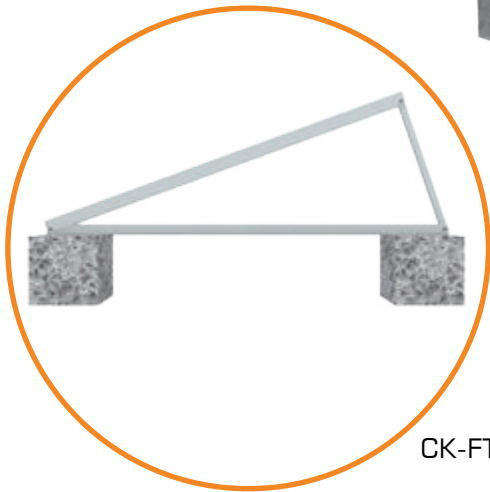
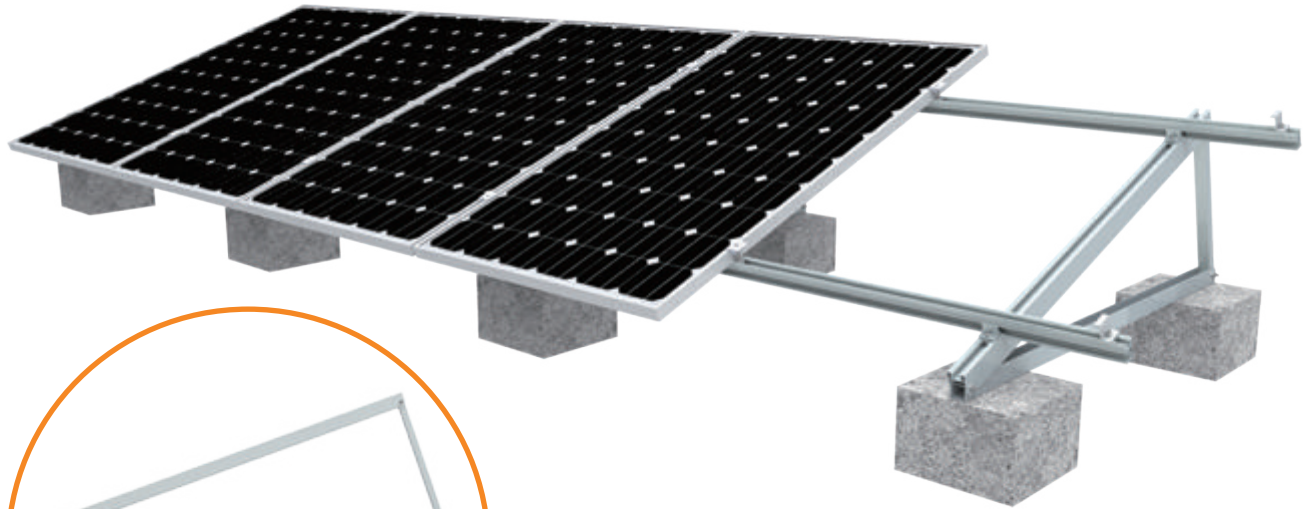

CK-FTT-BL

Features/Benefits:

- Most universal for commercial flat roofs
- 1 panel Portrait orientation
- 10°, 15°, 20°, 25° tilted angle available
- Made of AL 6005-T5
- Highly class anodizing on surface treatment
- Pre-assembly and foldable
- Non-penetration to roof with Lower cost



Tilt Mount On Metal Sheet

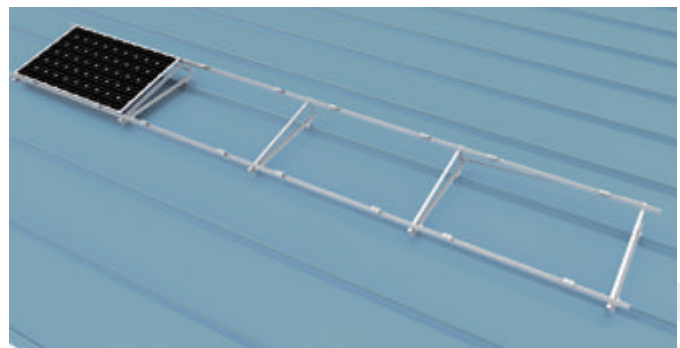



Classic Rail #7

Rail & Splice Kit



 <p>#7 Rail 4200,3200,2100mm</p>	 <p>Rail Splice Kit Spec:200mm</p>
 <p>Black #7 Rail 4200,3200,2100mm</p>	 <p>Black Rail Splice Kit Spec:200mm</p>













Mid Clamp & End Clamp

 <p>Mid clamp: 30/33/35/38/40/45/50mm</p>	 <p>End clamp: 30/33/35/38/40/45/50mm</p>
 <p>Black mid clamp: 30/33/35/38/40/45/50mm</p>	 <p>Black end clamp: 30/33/35/38/40/45/50mm</p>
 <p>Adjustable mid clamp: 30/35/40/45/50mm</p>	 <p>Adjustable end clamp: 35/40/45/50mm</p>
 <p>Thin Film Mid Clamp 5.6-7.3mm</p>	 <p>Thin Film End Clamp 5.6-7.3mm</p>









Infit Rail

Rail & Splice Kit

 <p>#516 Rail 4200mm,3200mm,2100mm</p>	  <p>#516 Rail Splice Kit Spec:150mm</p>
 <p>#517 Rail 4200mm,3200mm,2100mm</p>	  <p>#517 Rail Splice Kit Spec:150mm</p>
 <p>#518 Rail 4200mm,3200mm,2100mm</p>	  <p>#518 Rail Splice Kit Spec:150mm</p>
 <p>#519 Rail 4200mm,3200mm,2100mm</p>	  <p>#519 Rail Splice Kit Spec:150mm</p>

Mid Clamp & End Clamp

 <p>Mid clamp 30/33/35/38/40/45/50mm</p>	 <p>End Clamp 30/33/35/38/40/45/50mm</p>
 <p>Adjustable Mid Clamp 33-45mm</p>	 <p>Adjustable End Clamp 30-45mm</p>
 <p>Thin Film Mid Clamp 5.6-7.3mm</p>	 <p>Thin Film End Clamp 5.6-7.3mm</p>

Aluminum T2VC Mount

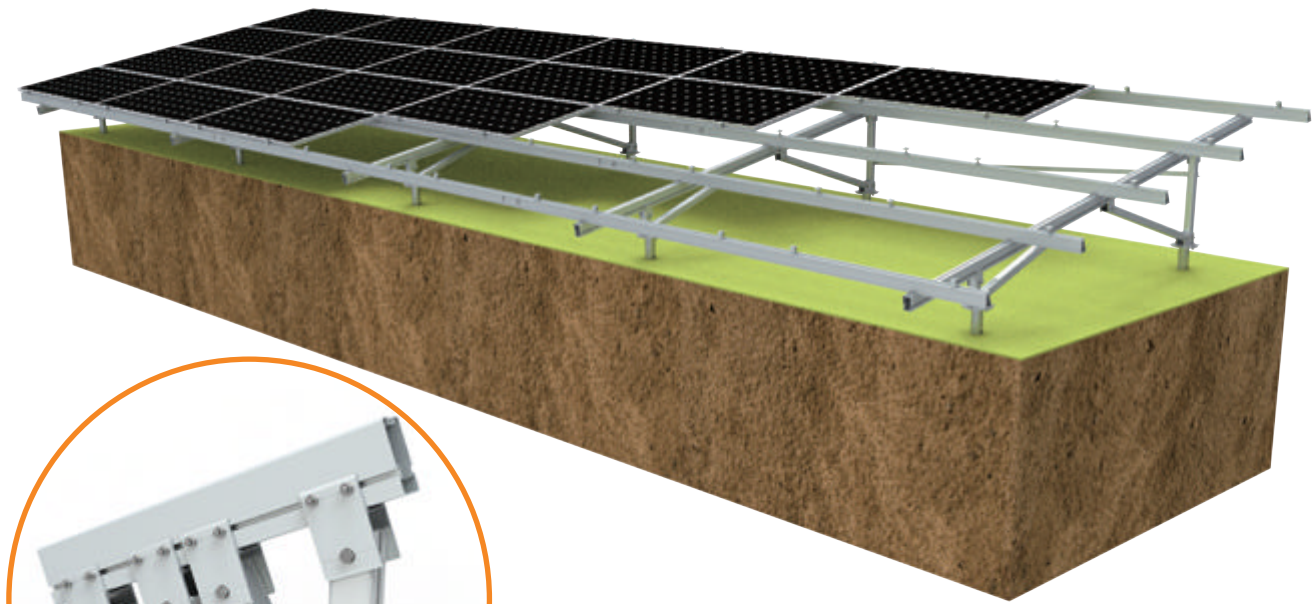

Features/Benefits:

- "V" support design, improve the stability
- Pre-assembly and foldable
- Portrait or Landscape orientation
- Made of AL6005-T5, Highly class anodizing
- Customized arrays and height are possible
- Foundation works with Concrete & Ground Screw & Anchor



Foundation Application

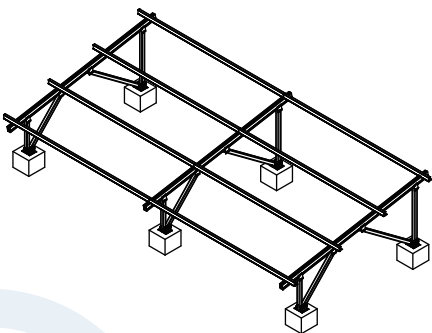

Concrete

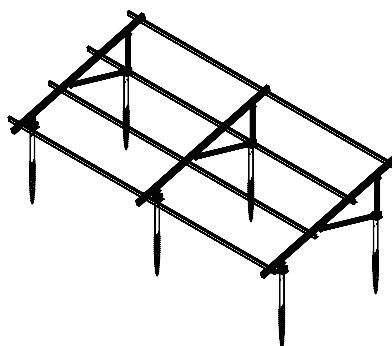

Ground screw

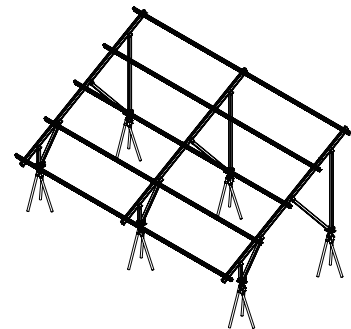

Anchor

Steel U2V Mount

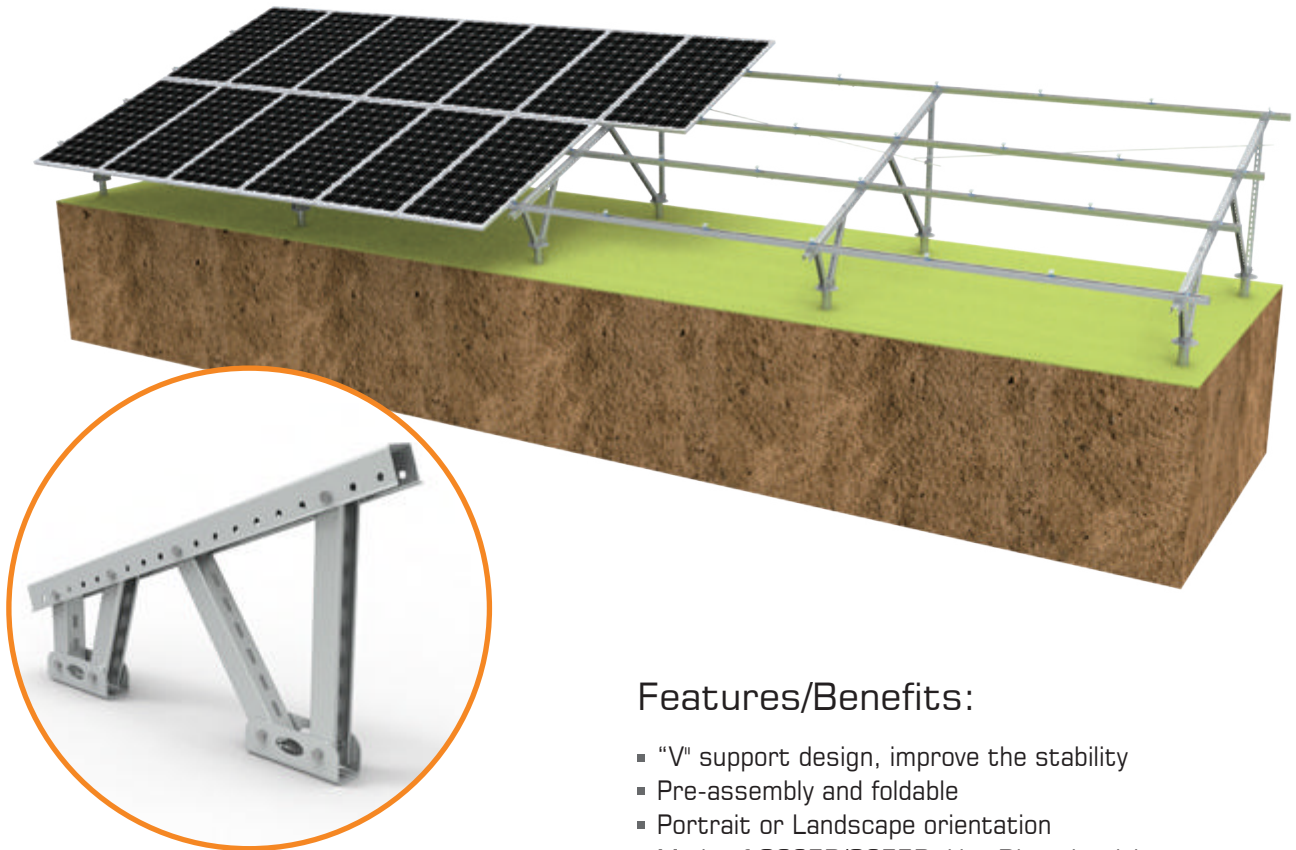

Features/Benefits:

- "V" support design, improve the stability
- Pre-assembly and foldable
- Portrait or Landscape orientation
- Made of Q235B/Q355B, Hot Dip galvanizing
- Customized arrays and height are possible
- Foundation works with Concrete & Ground Screw & Anchor



Height Customization

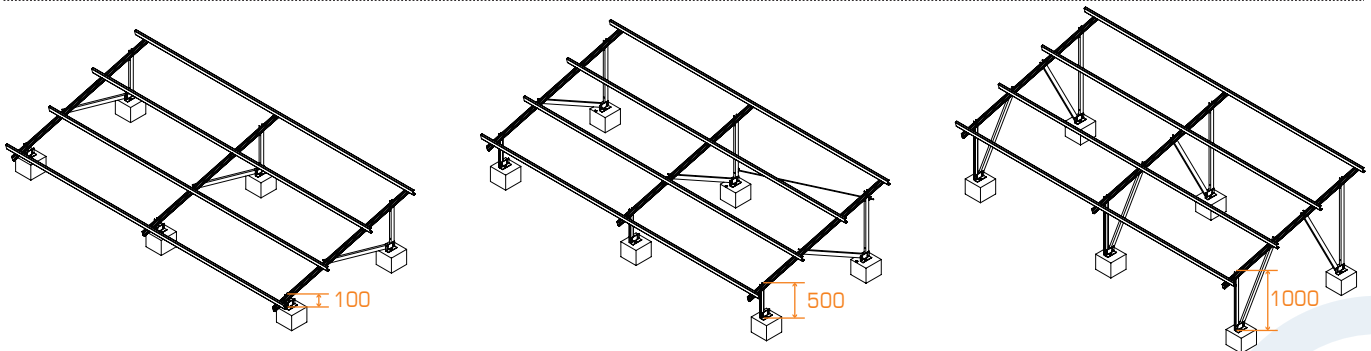

Steel Pipe Mount

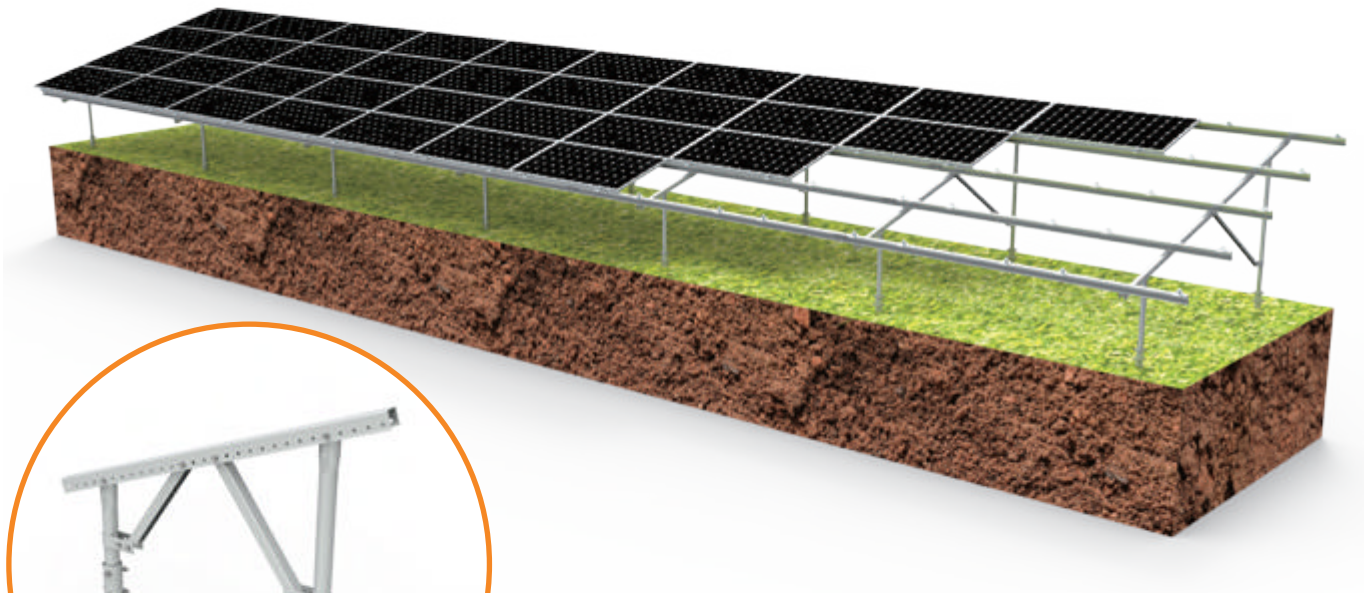

Features/Benefits:

- Specially pipe support
- Pre-assembly and foldable
- Portrait or Landscape orientation
- Made of Q235B/Q355B, Hot Dip galvanizing
- Customized arrays and height are possible
- Foundation works with Concrete & Ground Screw & Anchor



Foundation Application

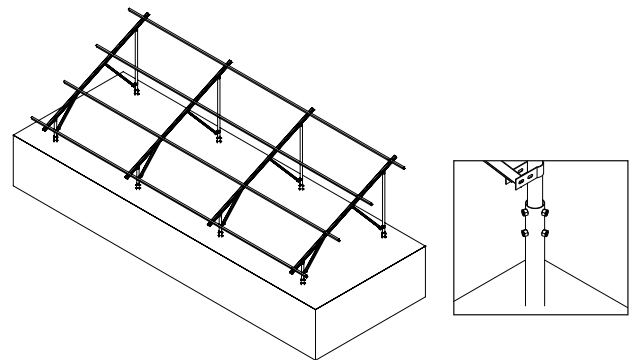
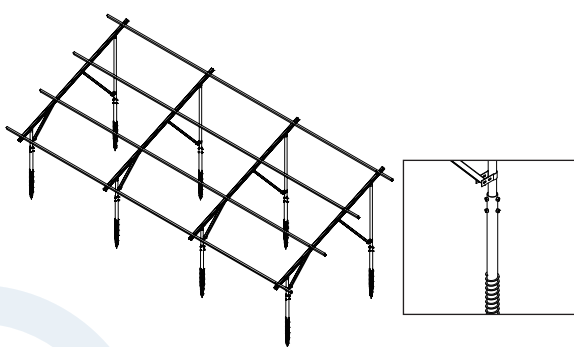

Pile-Driven Mount

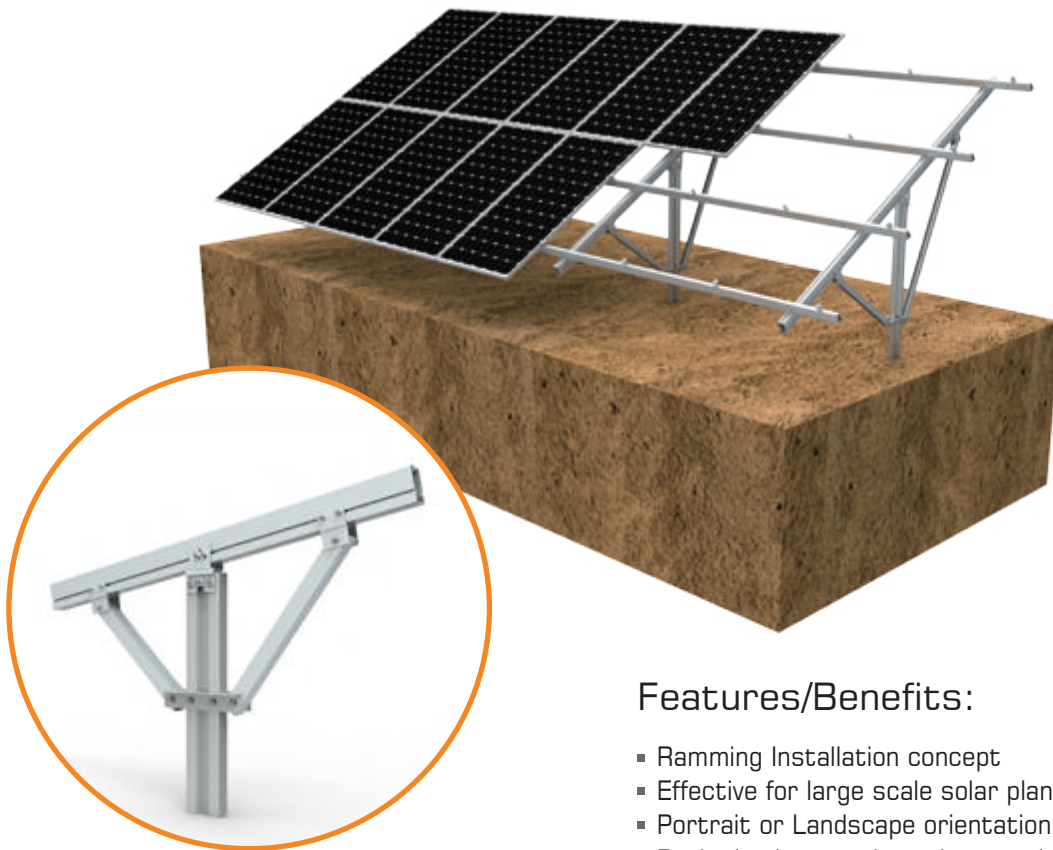

Features/Benefits:

- Ramming Installation concept
- Effective for large scale solar plant
- Portrait or Landscape orientation
- Both aluminum and steel are options
- Customized arrays and height are possible
- Foundation with pile only or combined with cement pouring



Angle Adjustable

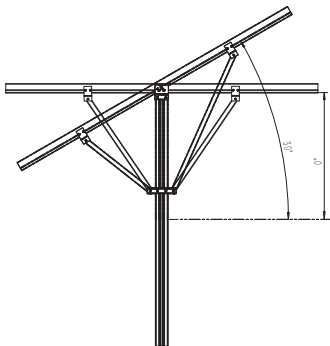

Larger Arrays

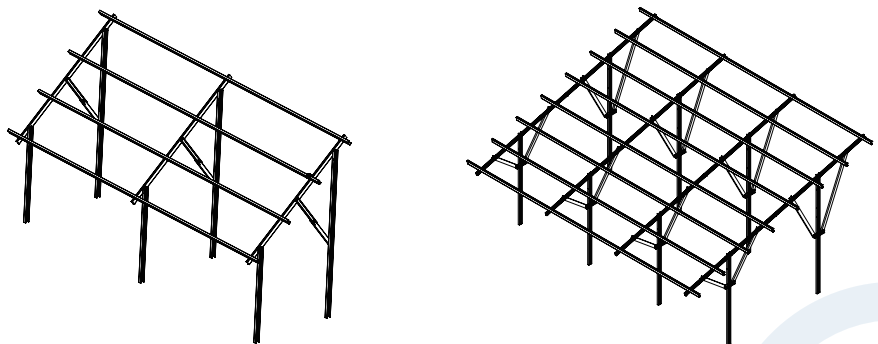

Single Pole Carport

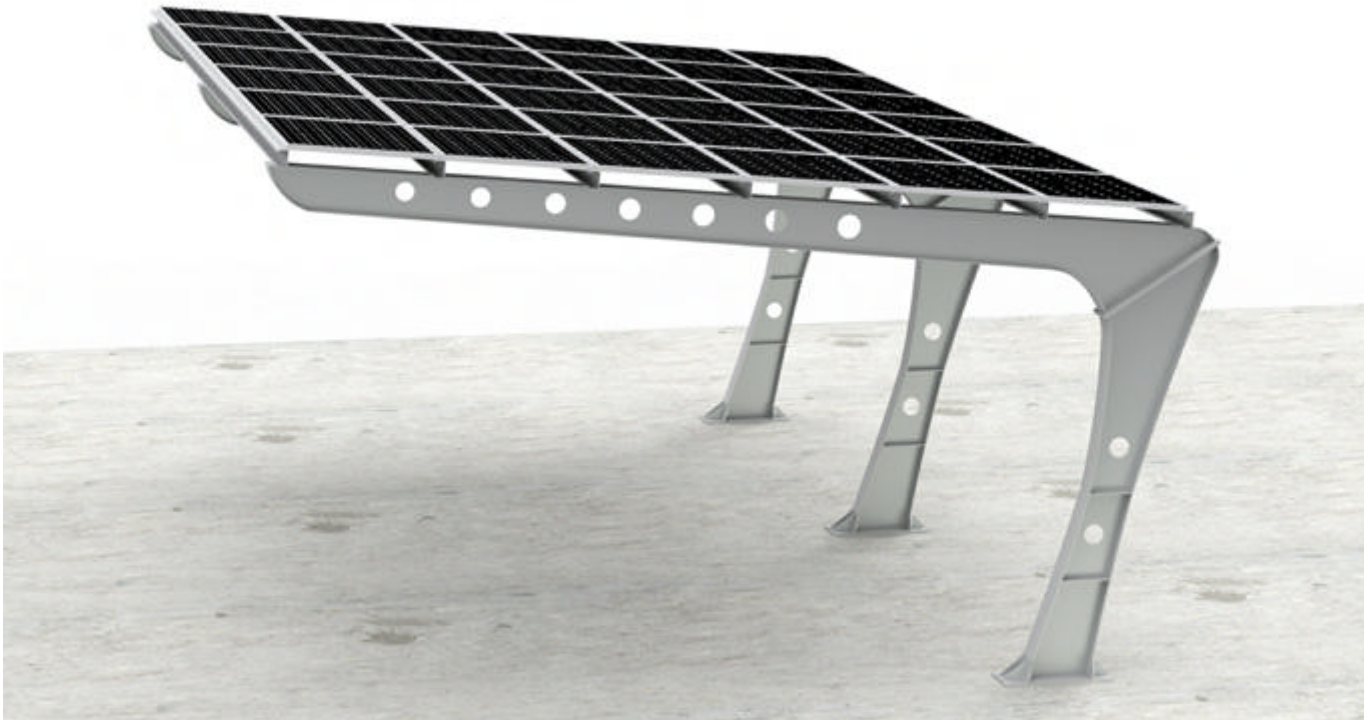

Features/Benefits:

- Mostly used for commercial parking lots
- Single pole, No obstacles between cars
- Portrait or Landscape orientation
- Made of Q355B, Hot Dip galvanizing or painting
- Double sides parking is available
- Water-proof option is provided
- Customized arrays and height are possible
- Strong calculation supported

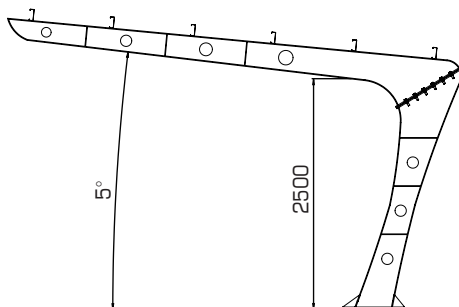

1 Side Parking

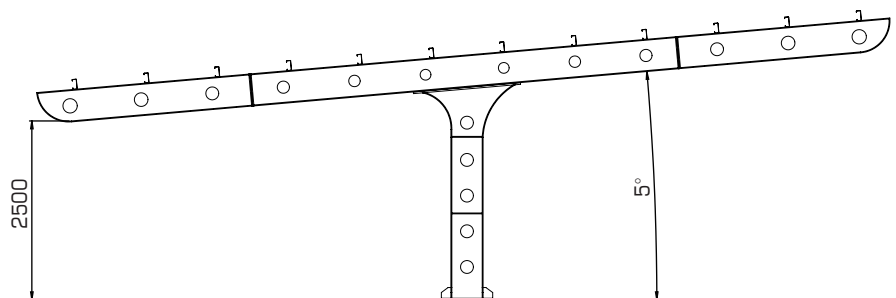

2 Sides Parking

Four Poles Carport

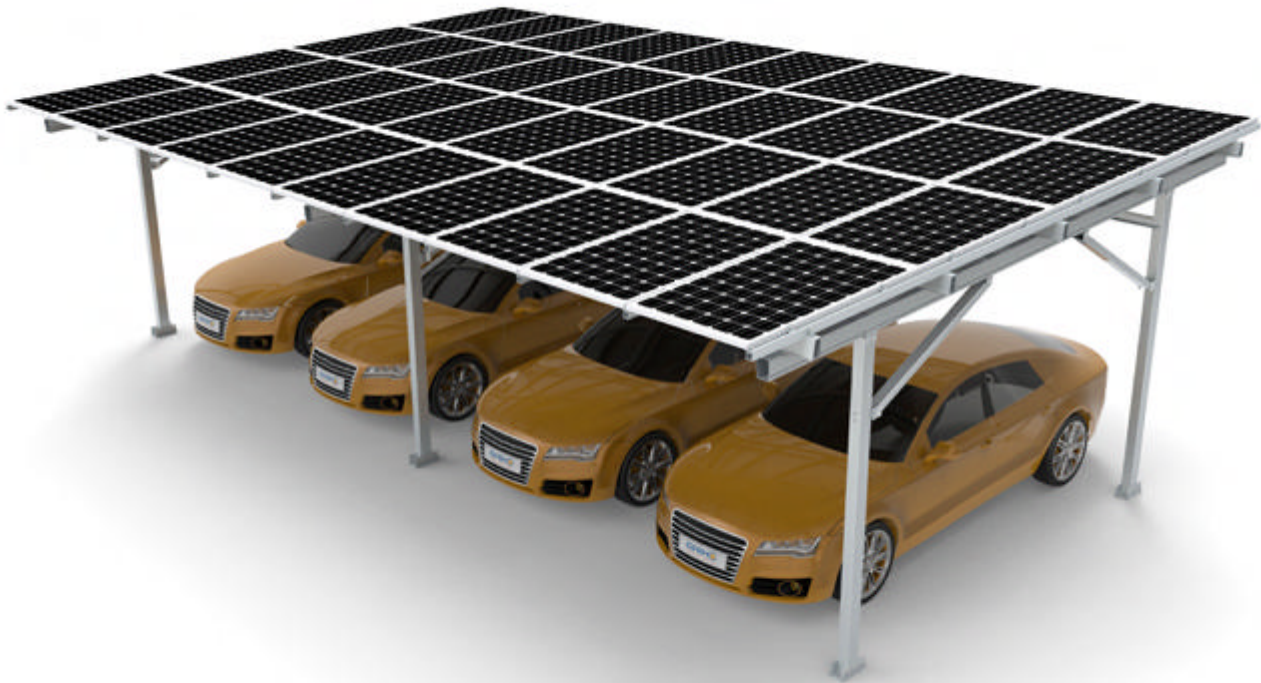

Features/Benefits:

- Mostly used for home parking lots
- Four Poles, 2 cars parking
- Portrait or Landscape orientation
- Both aluminum and steel are available
- Effective and convenient on installation
- Water-proof option is provided
- Customized arrays and height are possible
- Strong calculation supported

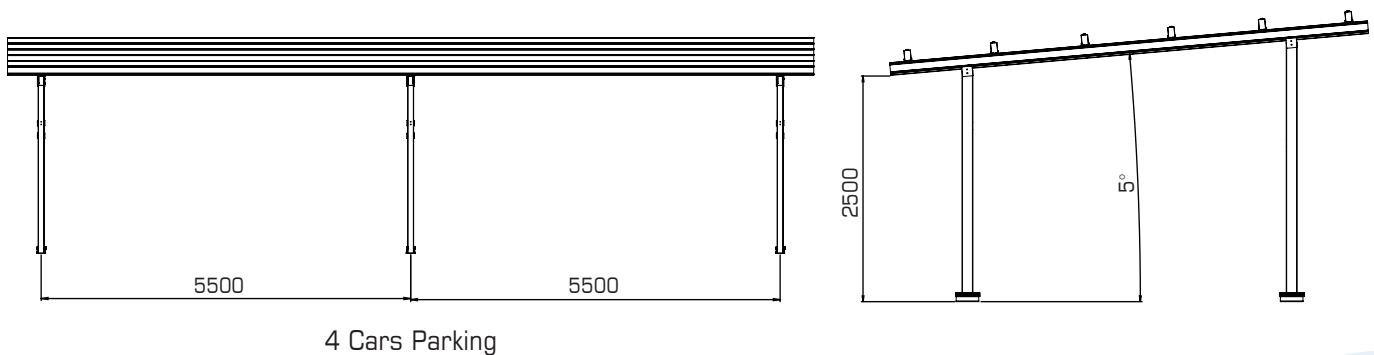

Adjustable Steel Ground Mount

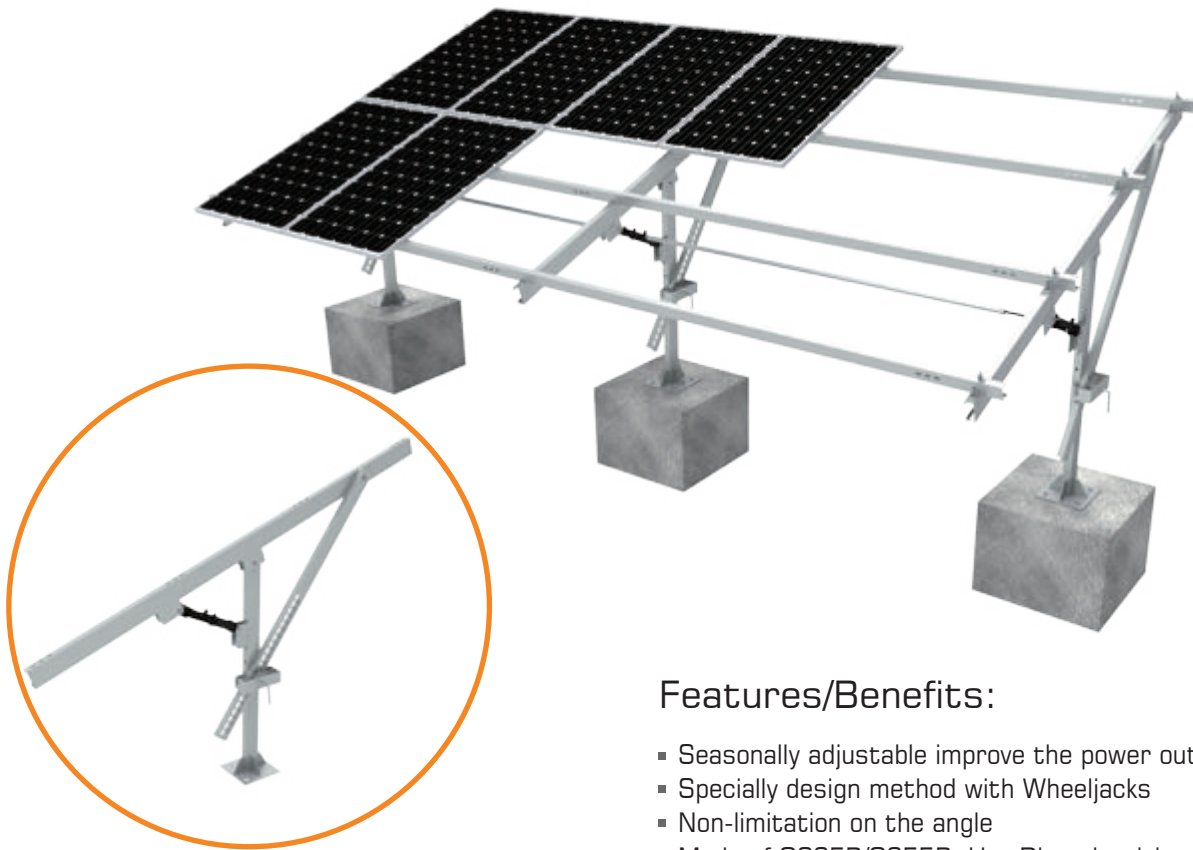

Features/Benefits:

- Seasonally adjustable improve the power output
- Specially design method with Wheeljacks
- Non-limitation on the angle
- Made of Q235B/Q355B, Hot Dip galvanizing
- Foundation works with both Concrete & Pile
- Enable the adjusting capacity 4MW/2persons per day



Customize Design

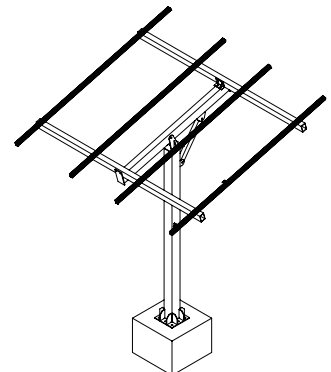
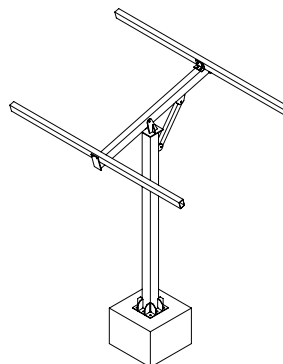
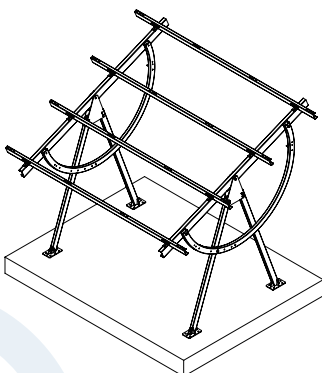

This product is designed to bond solar PV modules to mounting structures and create an electrical path to ground.

Earthing Clip



		CK-GTC-R3A CHIKO Grounding Clip (Open 8.5mm)
		CK-GTC-R3B CHIKO Grounding Clip (Closed 8.5mm)
		CK-GTC-R3C CHIKO Grounding Clip (Open 12mm)
		CK-GTC-R3D CHIKO Grounding Clip (Circle closed 8.5mm)
		CK-GTC-R3E CHIKO Grounding Clip for Adjustable Mid Clamp (Open 8.5mm)
		CK-GTC-R3F CHIKO Grounding Clip Closed 8.5mm for Ground Mount Mid Clamps
		CK-GTC-R3G CHIKO Grounding Clip For T Mid Clamps
		CK-GTC-R1 CHIKO Bonding Jumper
		CK-592-1 CHIKO Grounding Lug
		CK-FSC-ECPO1-205 CHIKO Bonding Jumper between Panels

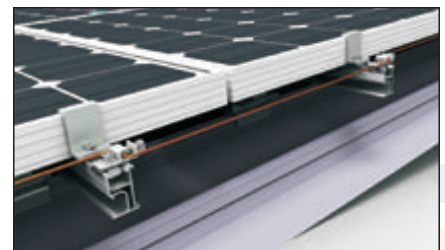
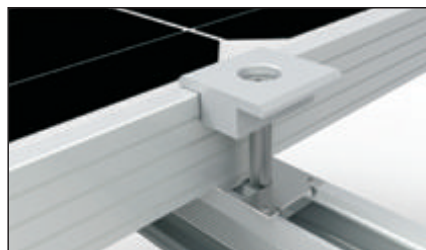
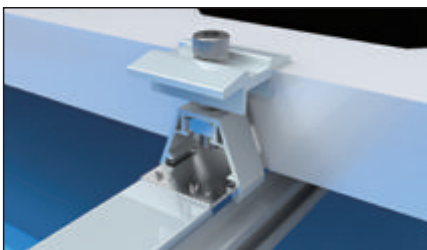

Ground screw type I with flange I

- Material steel Q235B
- High class hot galvanized 80 μ

Item No.	Diameter (mm)	Length(mm)	Thickness(mm)
CK-GS-F1-1200-3.0T	76	1200	3.0
CK-GS-F1-1600-3.0T	76	1600	3.0
CK-GS-F1-2000-3.0T	76	2000	3.0
CK-GS-F1-2500-3.0T	76	2500	3.0
CK-GS-F1-1200-3.5T	76	1200	3.5
CK-GS-F1-1600-3.5T	76	1600	3.5
CK-GS-F1-2000-3.5T	76	2000	3.5
CK-GS-F1-2500-3.5T	76	2500	3.5

Ground screw type I with flange II

- Material steel Q235B
- High class hot galvanized 80 μ

Item No.	Diameter (mm)	Length(mm)	Thickness(mm)
CK-GS-F2-1200-3.0T	76	1200	3.0
CK-GS-F2-1600-3.0T	76	1600	3.0
CK-GS-F2-2000-3.0T	76	2000	3.0
CK-GS-F2-2500-3.0T	76	2500	3.0
CK-GS-F2-1200-3.5T	76	1200	3.5
CK-GS-F2-1600-3.5T	76	1600	3.5
CK-GS-F2-2000-3.0T	76	2000	3.5
CK-GS-F2-2500-3.0T	76	2500	3.5

Ground screw type II with flange I

- Material steel Q235B
- High class hot galvanized 80 μ

Item No.	Diameter(mm)	Length(mm)	Thickness(mm)
CK-GSY-76F1-24-1200-3.0T	76	1200	3.0
CK-GSY-76F1-24-1600-3.0T	76	1600	3.0
CK-GSY-76F1-24-2000-3.0T	76	2000	3.0
CK-GSY-76F1-24-2500-3.0T	76	2500	3.0
CK-GSY-76F1-24-1200-3.5T	76	1200	3.5
CK-GSY-76F1-24-1600-3.5T	76	1600	3.5
CK-GSY-76F1-24-2000-3.5T	76	2000	3.5
CK-GSY-76F1-24-2500-3.5T	76	2500	3.5

Ground screw type II with flange II

- Material steel Q235B
- High class hot galvanized 80 μ

Item No.	Diameter(mm)	Length(mm)	Thickness(mm)
CK-GSY-76F2-24-1200-3.0T	76	1200	3.0
CK-GSY-76F2-24-1600-3.0T	76	1600	3.0
CK-GSY-76F2-24-2000-3.0T	76	2000	3.0
CK-GSY-76F2-24-2500-3.0T	76	2500	3.0
CK-GSY-76F2-24-1200-3.5T	76	1200	3.5
CK-GSY-76F2-24-1600-3.5T	76	1600	3.5
CK-GSY-76F2-24-2000-3.5T	76	2000	3.5
CK-GSY-76F2-24-2500-3.5T	76	2500	3.5



Adjustable ground screw type I without flange

- Material steel Q235B
- High class hot galvanized 80 μ

Item No.	Diameter(mm)	Length(mm)	Thickness(mm)
CK-GST-76N-1200-3.0T	76	1200	3.0
CK-GST-76N-1600-3.0T	76	1600	3.0
CK-GST-76N-2000-3.0T	76	2000	3.0
CK-GST-76N-2500-3.0T	76	2500	3.0
CK-GST-76N-1200-3.5T	76	1200	3.5
CK-GST-76N-1600-3.5T	76	1600	3.5
CK-GST-76N-2000-3.5T	76	2000	3.5
CK-GST-76N-2500-3.5T	76	2500	3.5



Adjustable ground screw type II without flange

- Material steel Q235B
- High class hot galvanized 80 μ

Item No.	Diameter(mm)	Length(mm)	Thickness(mm)
CK-GST-N16-1200-3.0T2	76	1200	3.0
CK-GST-N16-1600-3.0T2	76	1600	3.0
CK-GST-N16-2000-3.0T2	76	2000	3.0
CK-GST-N16-2500-3.0T2	76	2500	3.0
CK-GST-N16-1200-3.5T2	76	1200	3.5
CK-GST-N16-1600-3.5T2	76	1600	3.5
CK-GST-N16-2000-3.5T2	76	2000	3.5
CK-GST-N16-2500-3.5T2	76	2500	3.5



Adjustable ground screw flange I

- Material steel Q235B
- High class hot galvanized 80 μ

Item No.	Diameter(mm)	Length(mm)	Thickness(mm)
CK-AFP-76F1-500-3.0T	200	500	3.0
CK-AFP-76F1-800-3.5T	200	800	3.5



Adjustable ground screw flange II

- Material steel Q235B
- High class hot galvanized 80 μ

Item No.	Diameter(mm)	Length(mm)	Thickness(mm)
CK-AFP-76F2-500-3.0T	200	500	3.0
CK-AFP-76F2-800-3.5T	200	800	3.5



Anchor foundation

- Material steel Q235B
- High class hot galvanized 80 μ

Item No.	Description
CK-NK-03	Anchor foundation with 3 pipes
CK-NK-06	Anchor foundation with 9 pipes
CK-NK-12	Anchor foundation with 12 pipes



Cable Clip



CK-FSC-CP1/2/3

- CK-FSC-CP1** Solar cable clips 2.5 Hold one or two 2.5mm² solar cable
- CK-FSC-CP2** Solar cable clips 4.0 Hold one or two 4.0mm² solar cable
- CK-FSC-CP3** Solar cable clips 6.0 Hold one or two 6.0mm² solar cable

- Package 8000 PCS/CTN
- Weight 17.6 kg
- Made from stainless steel SUS304



CK-FSC-CP4/5

- CK-FSC-CP4** Solar cable clips 90°/180° 4.0 Hold one or two 4.0mm² solar cable
- CK-FSC-CP5** Solar cable clips 90°/180° 6.0 Hold one or two 6.0mm² solar cable

- Package 8000 PCS/CTN
- Weight 17.6 kg
- Made from stainless steel SUS304



CK-FSC-CP6

- CK-FSC-CP6** Solar cable clips to hold 3-4 cables, 3cables/6mm²; 4cables/4mm²

- Package 8000 PCS/CTN
- Weight 17.6 kg
- Made from stainless steel SUS304



CK-FSC-CP7/8

- CK-FSC-CP7** Solar cable clips 4.0 Hold four 4.0mm² solar cable for thin-film module
- CK-FSC-CP8** Solar cable clips 6.0 Hold four 6.0mm² solar cable for thin-film module

- Package 2400 PCS/CTN
- Weight 5.3 kg
- Made from stainless aluminum 6005-T5

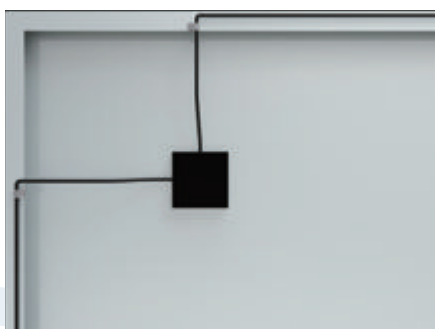

CK-FSC-CP1/2/3/4/5



CK-FSC-CP6

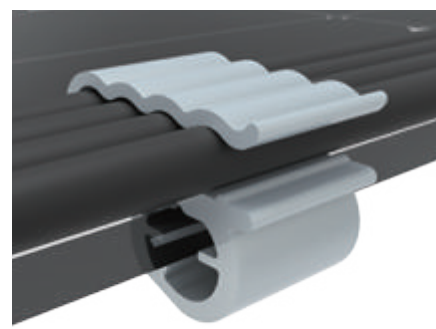

CK-FSC-CP7

Stainless steel cable tie

- Various length available
- Stainless Steel SUS304
- Unique buckle locking mechanism
- Fast & easy installation

Material in high quality SUS304			
Item	Width (mm)	Length (mm)	Package (pcs/pkg)
CK-FSC-TA-150	4.6	150	100
CK-FSC-TA-200	4.6	200	100
CK-FSC-TA-250	4.6	250	100
CK-FSC-TA-300	4.6	300	100
CK-FSC-TA-350	4.6	350	100

- Package 5000 PCS/CTN



PV Connector

CK-0807-A/B CK-0807-3A/3B CK-0808-A/B CK-0808-3A/3B
PV Junction Box adopts crowned spring and has automatic locking mechanism on plugs to ensure solid connection between contact and connector. Connector plug (negative) is equipped with buttons that are symmetric at the bottom to ensure the convenience of removal. Such removal does not need any extra instruments, therefore, can make sure that the plug is intact.

This advanced product, with easy usage, is more convenient to use than similar products. In addition, the product also confirms to DIN V VDE V 0126-3.



PV CONNECTOR



CK-0807-A/B-02
MC4 Single Connector
500 SETS/PKG



CK-0807-2A/2B-02
MC4 2-Branch Connector
100 SETS/PKG



CK-0807-3A/3B-02
MC4 3-Branch Connector
100 SETS/PKG

PV Cable

CHIKO Photovoltaic Cable

- Conductor : Tinned annealed copper
- Insulation : 120°CXLPE, black
- Jacket : 120°CXLPE, black
- voltage 600/1000V temperature 120°C
- Specifically designed for connecting photovoltaic system components inside and outside of building and equipment with high mechanical requirements and extreme weather conditions . For permanent installations.
- Cable made of electron-beam cross-linked insulation and coating; high resistance against heat, cold, oil, abrasion, ozone, UV and weather; with improved reaction in case of fire; low smoke, halogen free, flame free, flame retardant; flexible, easy to strip, very low space requirement, extremely mechanically robust, very long lifetime.

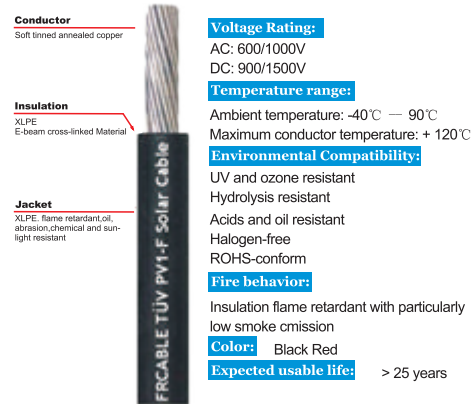

Construction

Type	Conductor		Insulation Standard Thickness	Insulation Standard Dia.	Jacket Standard Thickness	Outer Dia.	Conductor resistance (20°C)	Max. Current Carrying Capacity
	Construction	ConductorDia.						
mm ²	N/mm	(about)mm	mm	mm	mm	mm	Ω/KM	Apm
1.5	30/0.25±0.006	1.58	0.90	3.38 ± 0.1	1.10	5.5 ± 0.2	13.7	30
2.5	50/0.25±0.006	2.04	0.85	3.74 ± 0.1	0.90	5.5 ± 0.2	8.21	41
4.0	56/0.30±0.006	2.59	0.85	4.29 ± 0.1	0.90	6.10±0.2	5.09	55
6.0	84/0.30±0.006	3.17	0.85	4.87 ± 0.1	1.05	7.0±0.2	3.39	70

Electrical Properties

Item	Units	Specification
Conductor resistance (20°C)	Ω / km	—
Insulation resistance (90°C)	Ω / cm	≤ 10 ¹¹
Withstand voltage	V / 5min	AC6500
Lifetime	Year	≤ 25years
Min.Bending Radius		5D



CHIKO Photovoltaic Cable

Item	Description	Package(Meter/Roll)
CK-0809-1.5	Solar cable 1.5mm ²	250
CK-0809-2.5	Solar cable 2.5mm ²	250
CK-0809-4.0	Solar cable 4.0mm ²	100
CK-0809-6.0	Solar cable 6.0mm ²	200
CK-0809-10.0	Solar cable 10.0mm ²	100



PROJECTS REFERENCE





Project Size: 3MW Installation Site: Australia



Project Size: 200KW Installation Site: USA



Project Size: 650KW Installation Site: UAE



Project Size: 1.5MW Installation Site: Pakistan



Project Size: 3MW Installation Site: China



Project Size: 600KW Installation Site: Jordan



Project Size: 2MW Installation Site: Vietnam



Project Size: 2.1MW Installation Site: India



Project Size: 3.45MW Installation Site: Philippines



Project Size: 640KW Installation Site: Korea



Project Size: 500KW Installation Site: Japan



Project Size: 2.8MW Installation Site: China



GLOBAL NETWORK

D I S T R I B U T I O N



CHIKO 
Solar Mounting Solutions

Shanghai CHIKO Solar Technology Co., Ltd.

Add: No.680 Xingwen Road, Jiading District, Shanghai 201815 China

Tel: +86-21-59972267 / 59973712 / 59973713

Fax: +86-21-59972938

Email: sales@chikolar.com

www.chikolar.com